

**TANCO AUTOWRAP  
MODEL 580-S/580-A 2000  
OPERATORS HAND BOOK  
AND  
PARTS LIST  
WD66-580-S-M0300-N.T**



## GUARANTEE

Subject as hereunder provided, the Sellers undertake to correct either by repair or at their election by replacement any defect of material or workmanship which occurs in any of its goods within twelve months after delivery of such goods to first user, with the exception of contractors or commercial users when warranty period is six months.

In respect of Autowraps the warranty period is for 12 months or 8000 bales, whichever occurs first. In respect of Airways, tine breakage will be assessed on an individual basis in every case.

The term goods when used in this document means the article or articles described in Invoice as sold by the Sellers but does not include equipment or proprietary parts or accessories not manufactured by the Sellers. The Sellers, however, undertake to pass on so far as they legally can to the first user the benefit of any warranty given to the Sellers by the suppliers of such equipment, parts or accessories.

This understanding shall not apply to:-

- (a) Any goods which have been sold by the first user.
- (b) Any goods which have been injured by unfair wear and tear, neglect or improper use.
- (c) Any goods the identification marks of which have been altered or removed.
- (d) Any goods which have not received the basic normal maintenance such as tightening of bolts, nuts, tines, hose connections and fittings and normal lubrication with the recommended lubricant.
- (e) The use of any product on tractors exceeding the recommended horsepower.
- (f) Any goods which have been altered or repaired other than on instruction or with the written approval of the Seller or to which any part not manufactured or having written approval by the Sellers have been fixed.
- (g) Any second-hand goods or part thereof.

Any allegedly defective part or parts returned to the Sellers must be sent carriage paid. No claim for repair or replacement will be entertained unless upon discovery of the alleged defect written notification is sent to the Sellers giving, at the same time, the name of the Buyer from whom the goods were purchased and the date of purchase, together with full details of the alleged defect and the circumstances involved, also the serial number of the machine etc.

The Sellers shall be under no liability to their Buyers and first or subsequent users of their goods or to any other person or persons for loss or damages howsoever arising in respect of either personal injuries or for arising out of, or in any way connected with or arising from the manufacturers sale, handling, repair, maintenance, replacement or use of its goods or the failure or malfunction of any of its goods.

Representation and/or warranties made by any person (including Buyers and employees and other representatives of the Seller) which are inconsistent or conflicting with these conditions are not binding upon the Sellers unless given in writing and signed by a Director of the Sellers.

## CLAIMS.

If you wish to make a claim under guarantee:

- 1: Immediately, stop using the machine.
- 2: List the details of the machine, its serial number and the part number of the damaged part.
- 3: Consult with your Tanco dealer (supplier) and have him forward your claim and the damaged item to Tanco.

**INDEX**

**580S/580A MODELS**

**PAGE NO**

GENERAL SAFETY INSTRUCTIONS	1/2/3
SAFETY INSTRUCTIONS	4
SAFETY DECALS	5
TECHNICAL SPECIFICATIONS	6
PRE-DELIVERY INSTRUCTIONS	7/8/9
TRANSPORT INSTRUCTIONS	10
MACHINE IDENTIFICATION	10
PREPARATION OF A NEW MACHINE	10
HYDRAULIC CONNECTIONS	10
ELECTRIC CIRCUIT DIAGRAM 580S	11
USERS GUIDE - PX580S BALE COUNTER	12/13/14/15/16/17/18
JUNCTION BOX & CONTROLLER 580A	19
CONTROLLER FUNCTIONS	20/21/22/23/24/25/26/27/28/29
	30/31/32/33/34/35/36/37/38/39/40
MODE OF OPERATION	41
OPERATING INSTRUCTIONS	42
WARNING: LIFT ARM	42
FILM OVERLAP SYSTEM	43
SERVICE AND MAINTENANCE	44/45
FILM THREADING DIAGRAM	46
GEARBOX CHAIN DRIVE TENSIONING SYSTEM	47
TURNTABLE CHAIN DRIVE TENSIONING SYSTEM	48
FILM ADAPTOR OPERATING INSTRUCTIONS	49
ELECTRICAL COMPONENTS 580S MODELS	50
ELECTRICAL COMPONENTS 580A MODEL	51
HYDRAULIC CIRCUIT DIAGRAM 580S MODEL	52
HYDRAULIC CIRCUIT DIAGRAM 580A MODELS	53
HYDRAULIC COMPONENTS AND SEAL KITS 580S MODEL	54
PARTS LIST FOR ABOVE	55
HYDRAULIC COMPONENTS AND SEAL KITS 580A MODEL	56
PARTS LIST FOR ABOVE	57
FITTING 2 WAY SOLENOID VALVE	58
CONSTANT INDEXING DRIVE ASSEMBLY	59
PARTS LIST FOR ABOVE	60
AUTOWRAP ILLUSTRATED	61
PARTS LIST FOR ABOVE	62
TURNTABLE CHAIN DRIVE ASSEMBLY	63
PARTS LIST FOR ABOVE	64
LIFT ARM ASSEMBLY	65
PARTS LIST FOR ABOVE	66
FILM DISPENSING SYSTEM 580S/580A MODEL	67
PARTS LIST FOR ABOVE	68
VALVE/JUNCTION BOX/FILTER & DIVERTER VALVE MOUNTING BRACKET ASSEMBLY	69
FAULT FINDING SUMMARY	70
CUT AND START UNIT ILLUSTRATED	71
PARTS LIST FOR ABOVE	72
RECHARGING HYDRAULIC CYLINDER	73
TURNTABLE LOCKING ARRANEMENT	74
SENSOR AND MAGNET MOUNTING BRACKETS	75
HYDRAULIC BALE RAMP	76
PARTS LIST FOR ABOVE	77
LIGHTING KIT	78

## GENERAL SAFETY RECOMMENDATIONS

Before operating the machine, always ensure that the tractor and machine meet with work safety and road traffic regulations.

### BASIC PRINCIPLES

- 1 In addition to the recommendations given in this manual, legislation on work safety and accident prevention must also be respected.
- 2 Advice is indicated on the machine, specifying safety recommendations in order to prevent accidents.
- 3 Before travelling on public roads, the operator must ensure that the machine conforms to road traffic regulations.
- 4 Before starting work, the operator must be familiar with all machine controls, handling devices and their functions. once at work, it is too late to do this!
- 5 Do not wear loose clothing which could become caught up in moving elements.
- 6 The tractor should be equipped with a safety cab.
- 7 Before starting up the machine and beginning work, check the surrounding area (beware of children!) . make sure there is sufficient visibility. Keep all people and animals away from the danger zone of the machine (risk of projection!).
- 8 Carrying people or animals on the machine when working or in transport is strictly forbidden.
- 9 Machine must only be attached to tractor using means provided and in accordance with current safety standards.
- 10 Special care should be taken when attaching or removing the machine from the tractor.
- 11 Before transporting the machine on public roads, ensure that all legally required guards and indicators(lights, reflectors ... ) are in place and in good operation.
- 12 All operating controls (cords, cables, rods etc.) must be positioned so that they cannot be set off accidentally, risking accident or damage.
- 13 Before travelling on public roads, put the machine into its transport position as instructed in this operators manual.
- 14 Never leave the tractor seat while the machine is operating.
- 15 Drive speed must be adapted to ground conditions as well as to roads and paths. Always avoid abrupt changes of direction.
- 16 Before operating the machine, ensure that all safety guards are firmly in place and in good condition. If worn or damaged, replace immediately.
- 17 Before operating the machine, check the tightness of all nuts and bolts, particularly on fixing elements (blades, tines, knives, spades etc.,)
- 18 Keep clear of the machine operating area.
- 19 **WARNING!** Danger of crushing and shearing can exist when components are operated by hydraulic or pneumatic controls.
- 20 Before leaving the tractor or before adjusting, maintaining or repairing the machine, turn off the engine, remove the ignition key and wait until all moving parts have come to a complete stop.

- 21: Do not stand between the tractor and the machine unless the hand brake is tight and/or stops have been placed under the wheels.
- 22: Before any adjustments, maintenance or repairs are carried out, ensure that the machine cannot be started up accidentally.

#### ADDITIONAL RECOMMENDATIONS FOR LINKAGE MOUNTED MACHINES

- 1: Before attaching the machine, ensure that the front tractor axle is sufficiently ballasted. Ballast is to be placed on the supports provided in accordance with instructions of the tractor manufacturer.
- 2: Do not exceed the maximum axle load or the overall transport weight prescribed by the tractor manufacturer.
- 3: Precision steering, tractor adherence, road holding and efficient braking are influenced by the type of implement, weight, ballast of front axle, ground or road conditions. It is therefore of utmost importance to be cautious in every given situation.
- 4: Be particularly cautious when turning corners, paying attention to machine overhang, length, height and weight.

#### SAFETY RECOMMENDATIONS FOR ATTACHING IMPLEMENTS TO TRACTOR

- 1: When attaching or removing the machine from the tractor, position hydraulic lift control lever in such a way that it cannot be set off accidentally.
- 2: When attaching the machine to the tractor hydraulic linkage, ensure that diameter of the link pins corresponds to the diameter of the ball joints.
- 3: **WARNING!** Danger of crushing and shearing can exist in the lifting zone of the tractor hydraulic linkage!
- 4: Do not stand between the tractor and the machine when operating the outer lever of the lift mechanism.
- 5: In transport, the machine lift mechanism should be stabilized by tractor tie rods to avoid floatation and side shifting.
- 6: When transporting the machine, lock the hydraulic lift control lever in place so that it cannot be lowered accidentally.

## HYDRAULIC SYSTEM

- 1: **WARNING:** Hydraulic system is under pressure.
- 2: When fitting hydraulic motors or cylinders, ensure that connections have been made correctly, as per manufacturers instructions.
- 3: Before connecting hoses to the tractor hydraulics, ensure that tractor and machine circuits are not under pressure.
- 4: It is strongly recommended that the operator marks the hydraulic connections between tractor and machine to avoid making a wrong connection.  
**WARNING:** Functions could be reversed (for example: lift/lower)
- 5: Check hydraulic hoses regularly! Worn or damaged hoses must be replaced immediately. Replacement parts must be in accordance with the manufacturers recommendations concerning specifications and quality.
- 6: Should a leak be found, take all necessary precautions to avoid accidents.
- 7: Any liquid under pressure (particularly oil from hydraulics) can penetrate the skin and cause severe injury. If injured, see a doctor immediately, there could be a danger of infection.
- 8: Before any adjustments, maintenance or repairs are carried out, lower the machine, depressurize the circuit, turn off the engine and remove the ignition key.

## MAINTENANCE

- 1: Before checking for any machine malfunction and before adjusting, maintaining or repairing the machine turn off engine and remove ignition key.
- 2: Check tightness of nuts and bolts regularly. Retighten if necessary,
- 3: If the machine is raised, prop it up in a stable position before carrying out any maintenance work.
- 4: When replacing a working part, wear protection gloves and use only standardized tools.
- 5: It is forbidden to discard any oil, grease or filters. These must be given to waste disposal organisations to protect the environment.
- 6: Disconnect power source before any work is done to the electric system.
- 7: Check safety guards regularly, particularly those that are subject to wear. Replace immediately if damaged.
- 8: Spare parts used must be in accordance with specifications and standards as defined by the manufacturer. Use only genuine TANCO parts.
- 9: Before any electric welding is carried out on tractor or attached machine, disconnect generator and battery terminals.
- 10: Repairs on elements under pressure or tension (springs, accumulators etc-) must only be carried out by competent persons with standardized equipment.

### **SPECIAL SAFETY INSTRUCTIONS**

1. Stop engine of tractor before working on machine.
2. Put a suitable prop under raised platform before working in this area.
3. Always raise Lift Arm and fit safety prop before transporting machine on public roads.
4. Lift Arms should always be lowered before operating turntable.
5. Ensure platform rollers are parallel to Lift Arm before arm is raised.
6. On Autowrap models fitted with hydraulic bale ramp it is essential that the hydraulic hose is not disconnected from the hydraulic cylinder or hydraulic accumulator. This system is charged under pressure. Also, do not attempt to open the hydraulic accumulator as this is a pressurised unit.

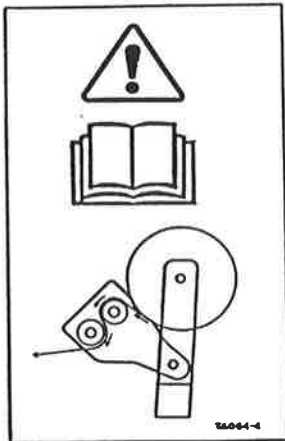
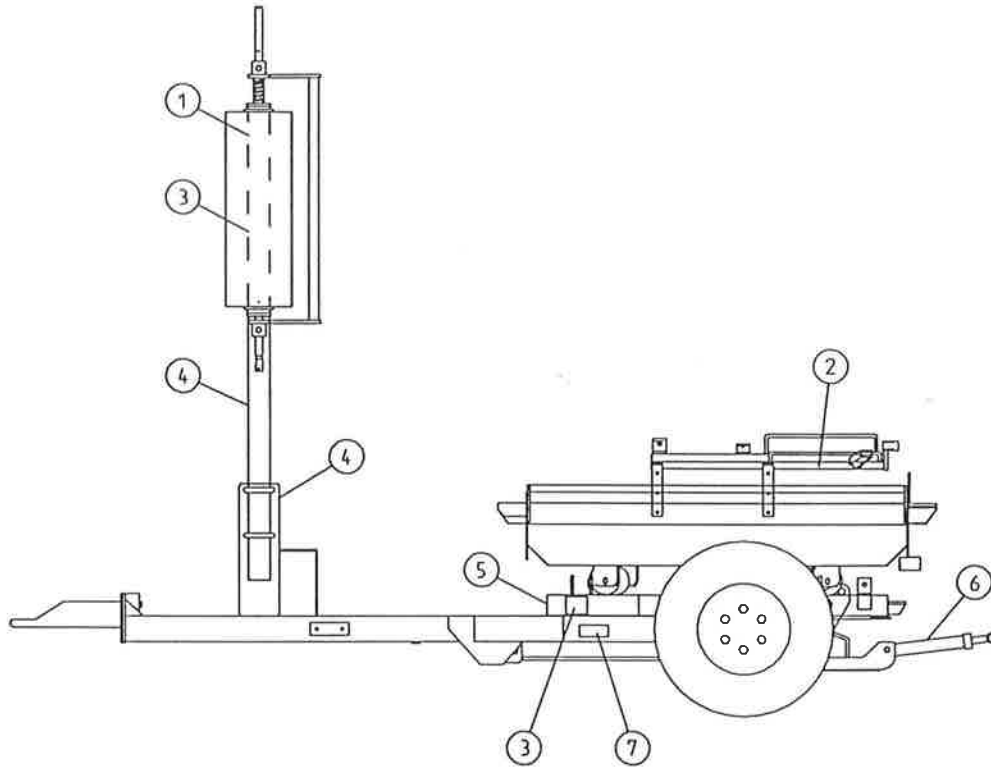
### **OPERATING SAFETY INSTRUCTIONS**

1. Operators should have their hands on the controls at all times when machine is in use.
2. Autowrap control unit and level controls must remain in the tractor cab at all times. The operator must at no time leave the tractor cab when the machine is in motion.
3. Keep onlookers clear of machine at all times. Danger zone is 5 metres.
4. Beware of rotating turntable and all moving parts.
5. If not operated correctly the bale could fly off the turntable. The end support rollers must always be fitted. Do not exceed recommended turntable speed of 30 r.p.m. Mis-shaped bales combined with excessive turntable speeds can be dangerous.
6. Care must be taken when tipping bales from machine on sloping ground and during subsequent handling to ensure that they do not roll, thus causing hazard.

**THINK OF YOUR PERSONAL SAFETY AND THAT OF OTHERS AT ALL TIMES.**

## SAFETY DECALS

The following safety decals have been placed on your machine in the areas indicated. They are intended for your personal safety and for the safety of the people working with you. With this manual, walk around your machine and note the content and location of these warning signs. Review these decals and the operating instructions in the manual with your machine operators. Ensure that these decals are always legible. If they are not replace them.



1. READ OPERATORS MANUAL



2. WARNING: SHARP BLADE



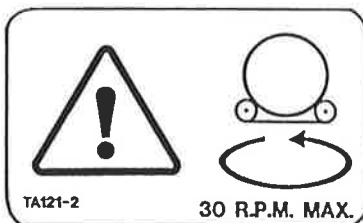
3. DANGER STAND CLEAR



4. BEFORE STARTING MACHINE  
READ OPERATORS MANUAL  
AND SAFETY INSTRUCTIONS



7. ENSURE THAT NUTS ARE  
KEPT TIGHT



5. DO NOT EXCEED TURNTABLE  
SPEED OF 30 R.P.M. MAX.



6. BEWARE: HOSES UNDER  
PRESSURE AT ALL TIMES

## TECHNICAL SPECIFICATIONS

### 58OS/58OA Models Trailed

#### Dimensions

Total length - Excluding Bale Ramp	350cm
Width - excluding lift arm	221cm
" - lift arm fully raised	243cm
" - lift arm lowered	380cm
Height to top of side (bale guide)rollers	110cm
Height to top of lift arm	242cm

#### Weight

With lift arm	1080kgs
Without lift arm	960kgs

#### Wheels

Size	10-80. 12
Pressure	42 P.S.i.

Lift arm capacity - Axle extended normally	750kgs
" " " - Axle extended fully	1000kgs

Speed of turntable	30 rev/min*
Oil requirement	(165kpcm <sup>2</sup> ) 25 lit/min

Attachment to tractor	Tractor Hitch
-----------------------	---------------

Bale Sizes	120 x 120cm up to 150 x 150 cm max weight of 1000kgs
------------	--

Film (Width of Roll)	750mm Optional 500mm
----------------------	-------------------------

The speed of rotation can be varied to suit various conditions but on no account should it exceed 30 r.p.m. (Speed in excess of 30 r.p.m. will void warranty).

## PRE DELIVERY INSTRUCTIONS

**IMPORTANT: DO NOT ATTEMPT TO OPERATE UNTIL THE FOLLOWING INSTRUCTIONS ARE PERFORMED OTHERWISE SERIOUS DAMAGE COULD BE CAUSED**

### 1. MACHINE ASSEMBLY

For ease of transportation some items are removed from their positions and stored elsewhere on the machine. The control box, film dispenser and cut and start unit are stored under the bale belt. Also stored under belt on remote control machines are the infra red receiver and sender units and warning beacon. The film mast is attached to the front of the machine. On round bale machines only, the top rollers c/w mounting brackets and the plastic end rollers are mounted on temporary brackets beside the bale belt. Road wheels, bale lift arm and bale ramp are transported separately. Remove the above items and assemble as detailed in parts list section of this manual taking particular note of the following points.

#### (i) DISPENSER MAST

Insert lift mast into socket towards front of machine. Ensure film pull down ram is faced towards the machine. Attach the pull down arm hydraulic ram. Attach the film dispenser to the mast ensuring that the end marked top is faced up. On remote control machines attach the infra-red receiver and warning beacon to top of mast. The film mast height is adjustable. Its height is dependant on bale size and type and is set in the field.

It should be set so that centre line of film is in line with centre of bale. See Fig. 1

#### (ii) CUT & START

Attach Cut & Start unit to mounting frame on the left hand side of the machine. It is possible to move the unit along the mounting and fix it to any of three holes. On all round bale wrapping machines the unit is fixed to the centre hole on the mounting frame. The hose is stored on the turntable frame near the Cut & Start mounting.

#### (iii) BALE LIFT ARM

Assemble bale lift arm and attach to mounting points on right hand side of main chassis. Attach hydraulic ram to lift arm; grease pivot pins.

#### (iv) TOP ROLLERS AND PLASTIC END ROLLERS

Place plastic end rollers in sockets on the back and front of the turntable. On round bale machines only, attach top rollers and mounting brackets to each side of the machine.

(v) ROAD WHEELS (trailed machines only)

Attach road wheels ensuring that nuts are tight and tyre pressure is 50 p.s.i.

(vi) BALE RAMP OR MAT

Attach bale ramp or mat to rear of chassis. Note Round bale trailed models have bale ramps with an option of hydraulic bale ramp.

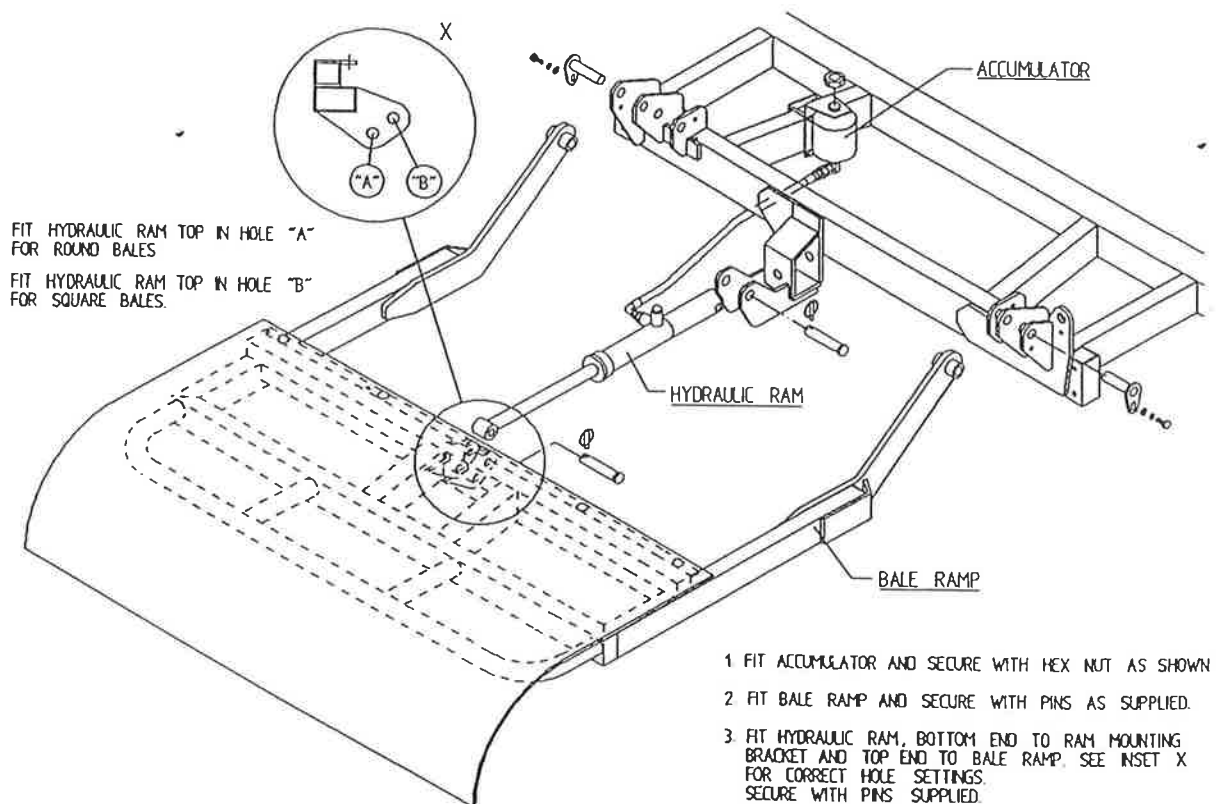
Linkage mounted machines have bale mats. The standard 1050 trailed models have hydraulic bale ramps.

SEE INSTRUCTION BELOW FOR FITTING HYDRAULIC BALE RAMP.

CHECKS TO BE PERFORMED

1. Check that all bolts and nuts are tight.
2. That all lubrication points are greased.
3. Check that all guards are in place.
4. Check all operating and safety stickers are in place.

INSTRUCTIONS FOR FITTING HYDRAULIC BALE RAMP



## 2. OPERATIONAL TEST

When all above assembly and checks have been carried out the operation of the machine should be checked as follows:

**NOTE: IF YOU ARE NOT TOTALLY FAMILIAR WITH THE OPERATION OF THE TANCO CONTROL SYSTEM THIS MANUAL IN FULL BEFORE PROCEEDING WITH OPERATIONAL TEST.**

1. Attach machine to tractor.
2. Connect hydraulic hoses to D/A service on tractor.
3. Fit controller box inside cab.
4. Connect control box to machine and connect power cable direct to tractor battery. It is important that the leads are connected with the correct polarity.
5. Fit cable control actuator socket to convenient position in cab and locate actuators in socket.
6. Lock hydraulic lever in tractor so that oil is flowing through system.
7. Check function by operating control levers.
  - (a) Lift arm up and lift arm down. **NOTE:** ensure lift arm is down before moving to (b).
  - (b) Turntable rotation forward and reverse.
  - (c) Tip up and down checking hoses are o.k.

## 3. CUSTOMER CHECKS

Before despatching consult customer on the following points:

1. That the machine model suits his requirements.
2. If machine is to be operated on a tractor with a closed centre hydraulic system then a closed centre valve is required, see separate instructions.
3. That the tow hitch type is compatible with the tractor. Three different hitch types are available.

## TRANSPORT INSTRUCTIONS

1. Never use straps around the machine when lifting. Use only the following lifting points:- Tow hitch and two sockets on each side of main frame at rear for trailed models. 3 pt. Linkage frame and two sockets on each side of main frame at rear for 3 pt. Linkage Model.
2. When the machine is towed on the road the Lifting Arm (if fitted) must be in the fully raised position, the safety prop fitted and the axle returned to narrowest position.
3. Raise the Parking Jack on trailed models before moving machine-

## MACHINE IDENTIFICATION

The Serial Number plate is located on main frame forward of offside wheel on trailed models and on 3pt. Linkage frame for 3pt. Linkage model.

Always refer to this number when ordering parts. The Spare parts catalogue number and description should be used. The reference numbers are used to help identifying the spare part.

For your records write serial number here.

## SERIAL NO.

## PREPARATION OF A NEW MACHINE

1. Check height of film mast to ensure that centre line of film spool is level with the centre line of the bale on the turntable. This will alter with different bale diameters. If this alignment is not correct more film than necessary will be used. See fig 1.
2. When connected to John Deere\* tractor the valve must be converted to closed centre.

## HYDRAULIC CONNECTIONS

Connect the feed and return hoses from the Autowrap valve to the tractors double acting facility.

**NOTE:** The return hose is fitted with a non-return valve to protect the Autowrap from damage in the event of incorrect connection to tractor hydraulics.

**NOTE:** To ensure maximum efficiency and length of lift of hydraulic components this machine requires a clean supply of hydraulic oil.

**IT IS RECOMMENDED THAT THE TRACTOR HYDRAULIC FILTER ELEMENT TO BE REPLACED AND THERE AFTER MAINTAINED IN ACCORDANCE WITH THE MANUFACTURERS RECOMMENDATIONS.**

# TANCO AUTOWRAP 580S MODEL ELECTRIC CIRCUIT DIAGRAM

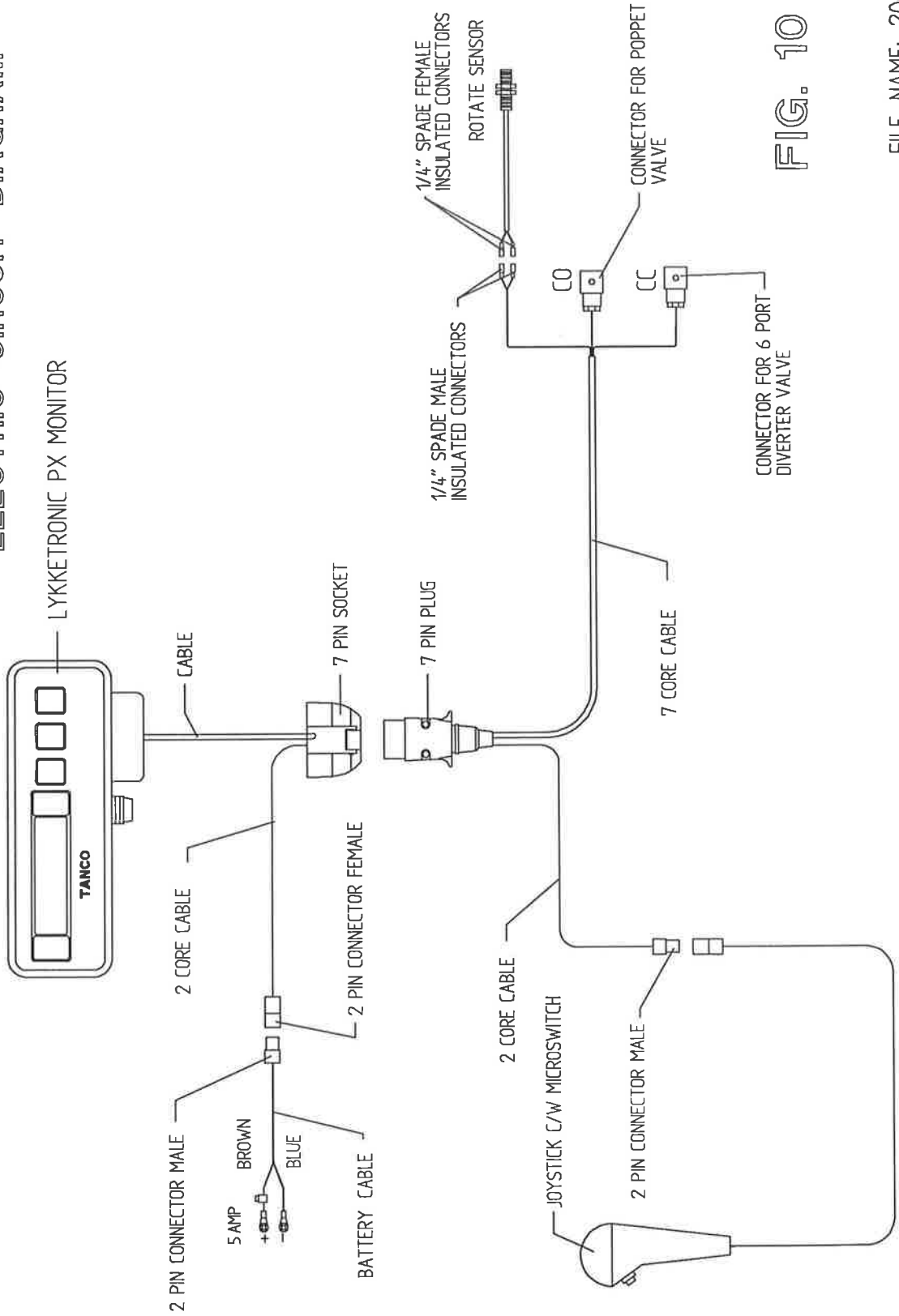
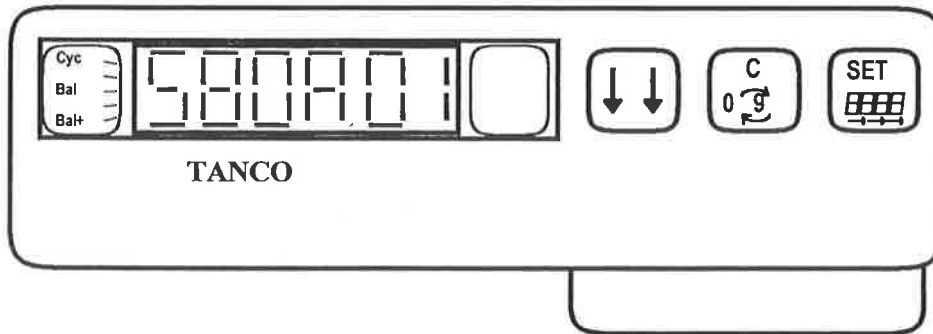


FIG. 10

FILE NAME: 2003 A

# User's Guide -PX 580S Bale Counter

Software version 580A.03




## Description of Bale Counter 580 A.


### The computer :

1. Counts the number of bale rotations.
2. Activates audio and visual alarm at ( n-1 ) programmable turns.
3. Count the number of completed bales in two counters.
4. Automatically releases the film at ( -2 + n ) programmable turntable revolutions.
5. Manual cutter open / close operation. Electronically operated on the joystick.

## DISPLAY DESCRIPTION, THE KEYS AND THEIR FUNCTIONS.

### Function of the keys.

The  key is used for scrolling forward in the menu and to exit programming

The  key is used for entering programming mode and digit select and digit SET when in programming mode.

The  key is used in programming mode for digit value changing and also for

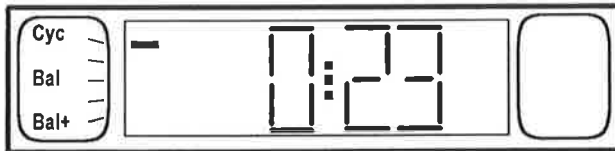
the activation of the CUTTER OPEN or CLOSE function and to annulment of a cycle/ applied Turntable revolution.


**The display menus.**

When the power is connected, the display will show the software version number ( see picture page 1 ), followed by the “Cycle mode” as shown this picture immediately above.

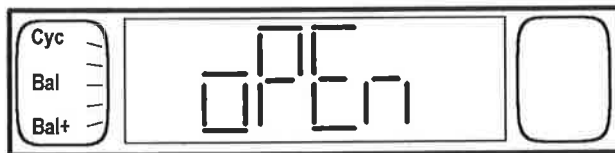
A display segment points at the mode in which the computer is operating. Referring to the picture below, the display is showing the cycle data ( CYC ). where 0 of the 23 required turns are made.


“CYC”            Displays the Cycle status.



Now pushing the  key will gain access to the **manual CUTTER OPEN** function. The **OPEN CUTTER** is now activated depressing the “ C “ Button. ( oPEn:on )

“OPEN”            Manual cutter open facility.



Now referring to the “ ( CYC “) display previous page, pushing the  key will gain access to the **manual CUTTER** function. The **CUTTING** is now activated depressing the “ C “ Button. ( cut : on.)


“CUT ”            Manual cutter close facility.



The cutter open / close function may also be operated on the pushbutton on the joystick.

<p>Table tip to horizontal + push button is cutter open.</p>		<p>Table tip up + push button is Cutter close.</p>
<p>The display will indicate OPEN.</p>		<p>The display will indicate CUT.</p>

**DISPLAY MENUS CONTINUED:**

Now pushing the  key will advance the indicator segment one step and thus show number of wrapped bales on the reset able counter.

"BAL" Displays the number of wrapped bales. ( Reset able counter.)







Now pushing the  key once more, will advance the indicator segment one step further and now show "total number of wrapped bales".

"BAL+" Total number of wrapped bales.( Non-reset able counter.)









**PROGRAMMING.**

To enter the programming mode, depress the  : for 1 second while the display segment points at the "CYC" symbol on the top left side of the display. The display wil now change to show the below.

The most significant digit will flash, If required increased or decreased, pres the  key, if not press  : for next digit and again  for value change.

Setting the required number of layers. "CYC"  
**Changing from 20 to 23 required turns.**

Key	Display	Explanation:
	20	Find the Wrap cycle "CYC".
	<b>20</b>	Press key for 1 second - the number starts flashing.

	20	Press key in steps until value is as required. <b>OR</b>
	20	Press key to advance to next digit <b>NOW</b>
	23	Press key in steps until value is as required. <b>NOW</b>
	0 : 23	Press key in steps in order to exit programming and to re-enter operative mode. The display will then show (CYC)

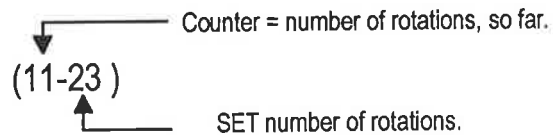
### FILM RELEASE AND FILM CUTTING.

The turntable sensor will upon the reception of the 2nd turn signal, open the cutter and release the film. This output is active for 5 seconds.

When tipping off the bale, and the button on the joystick is pushed, the cutter output is active for 2 seconds, the Turntable will stop tipping and the cutter will close for this period, where after the table tipping will continue.

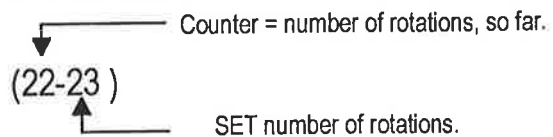
### BALE COUNTING.

When the display is showing the "cycle mode" (a display segment is aligned with "CYC" ) 2 numbers are shown:



For the specific example, when the number to the left equals the number to the right minus 1 (e.g.  $23-1=22$  ), the acoustic alarm will be activated. The alarm will continue the following 10 seconds, or until the next rotation is completed. In case the bale is wrapped further, the alarm will sound for 2 seconds after each additional bale-rotation.

Alarm is called up when  
number of turns are (n-1) turns.



When the ("number of rotations, so far") equals the "SET number of rotations", the computer registers, that one more bale has been wrapped and the number of wrapped bales "Bal" and "Bal+" are both increased by one (+1).

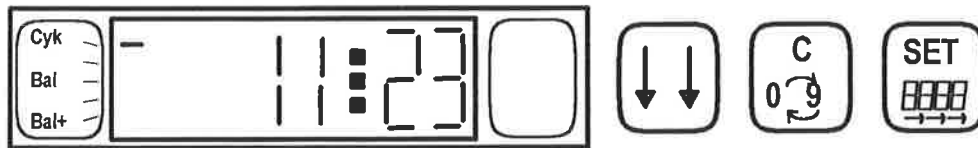
5 seconds after the last rotation, the display automatically shows the number of bales wrapped (Bal).

If the turntable is not rotated further within the next 10 seconds (after the last rotation), the computer resets the wrap counter ("number of rotations, so far"), and is ready for the next bale.

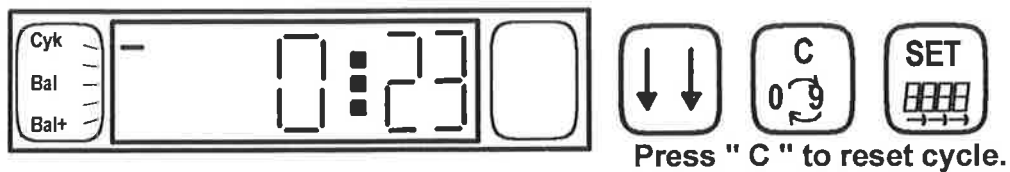
**APPLYING ADDITIONAL FILM.**

If additional film is applied ( turntable is rotated n + x turns ) within 10 seconds after the programmed number of turns are applied the computer will assume, that the same bale is still on the table, activate the audio alarm indicating this is “ outside program operation “ and display the additional turns on the “ number of rotations, so far”.

**RESETTING A CYCLE**



When the display shows "CYC", the "number of applied rotations, so far" can be reset by pressing <sup>C</sup><sub>0.9</sub> button if it should be necessary not to include the already applied turns to a bale. If the required number of turns are applied to the bale, the cycle cannot be reset.







**THE BALE COUNTERS.**

The bale counters ("Bal" and "Bal+") both count up to 99.999 bales, whereupon they are automatically reset.

At any time it is possible to reset the "Bal"-balecounter.

### Resetting the bale counter "Bal"

Key	Display	Explanation:
	126	Find the bale counter "Bal".
	126	Press key for 1 second - the number starts flashing.
	0	Press key to reset that bale counter.
	0	Press key to exit programming, and enter normal operation.

The Bal+ can not be reset .

#### **The outputs.**

The computer is equipped with an internal audio alarm, an output for the cutter open function and an output for the cutter close function.

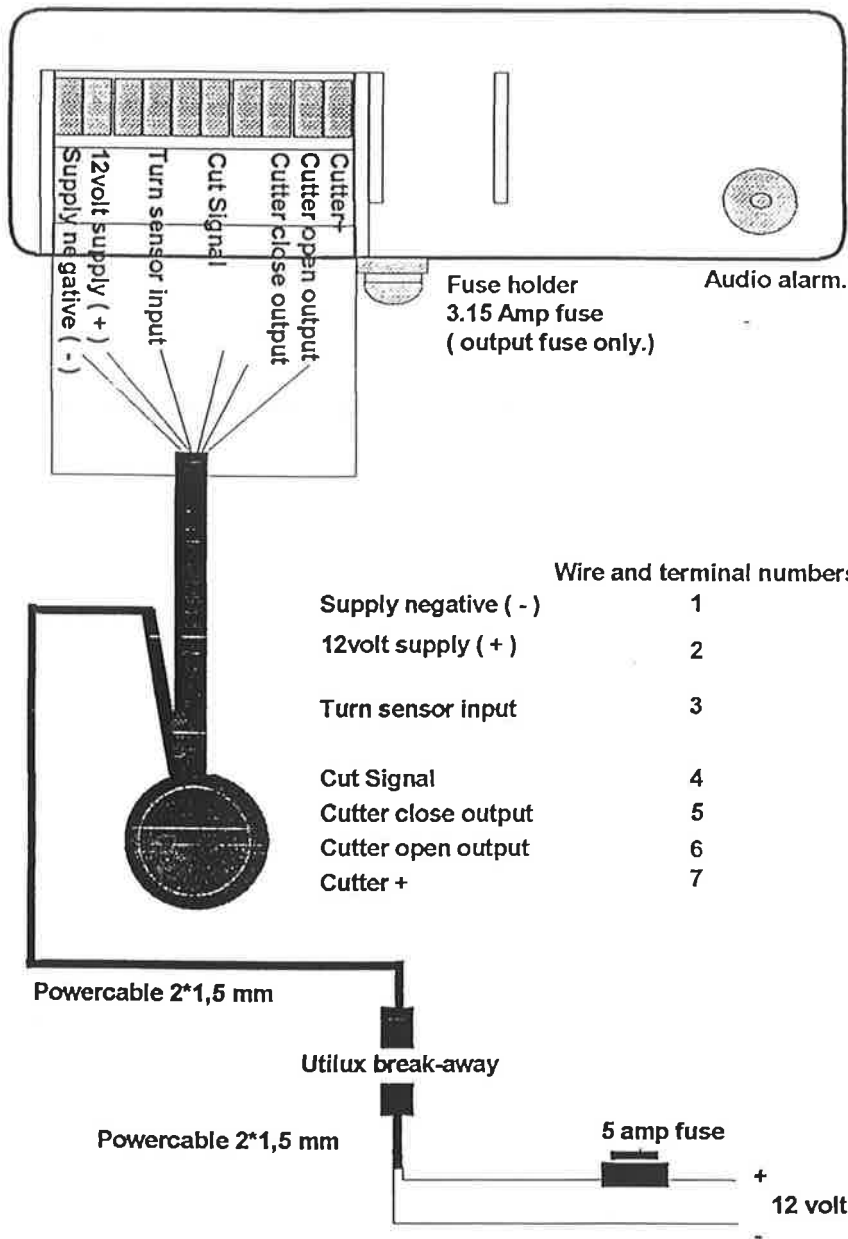
The outputs are active low and secured with a = 3,15 Amp. fuse.

#### **Computer memory.**

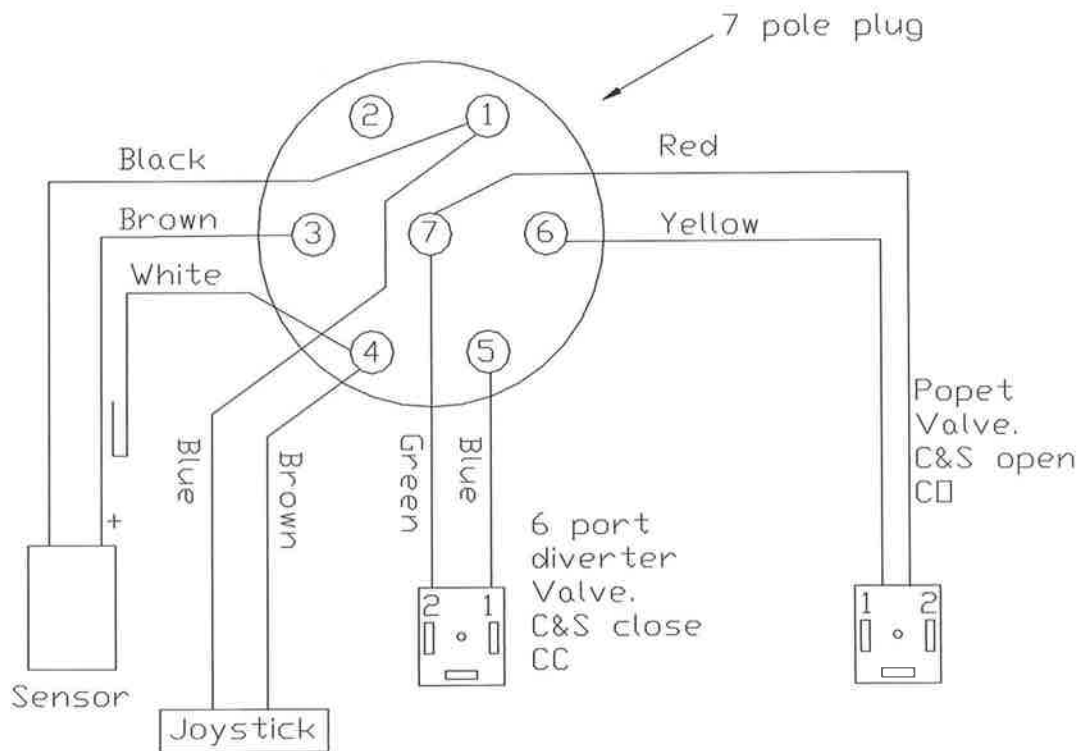
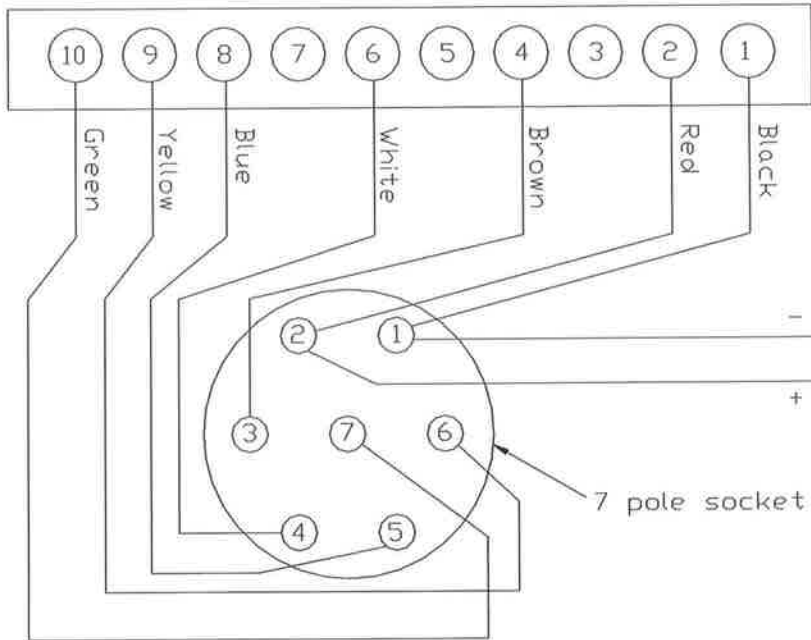
The computer is equipped with a memory which stores and recalls all values programmed and accumulated, when the power to the unit is disconnected / connected.

#### **Installing the computer.**

The sensor to the computer has to be connected as shown in the supplied diagram, Fig 10 and in such a fashion that chances of damage to the cable and sensor is minimal.

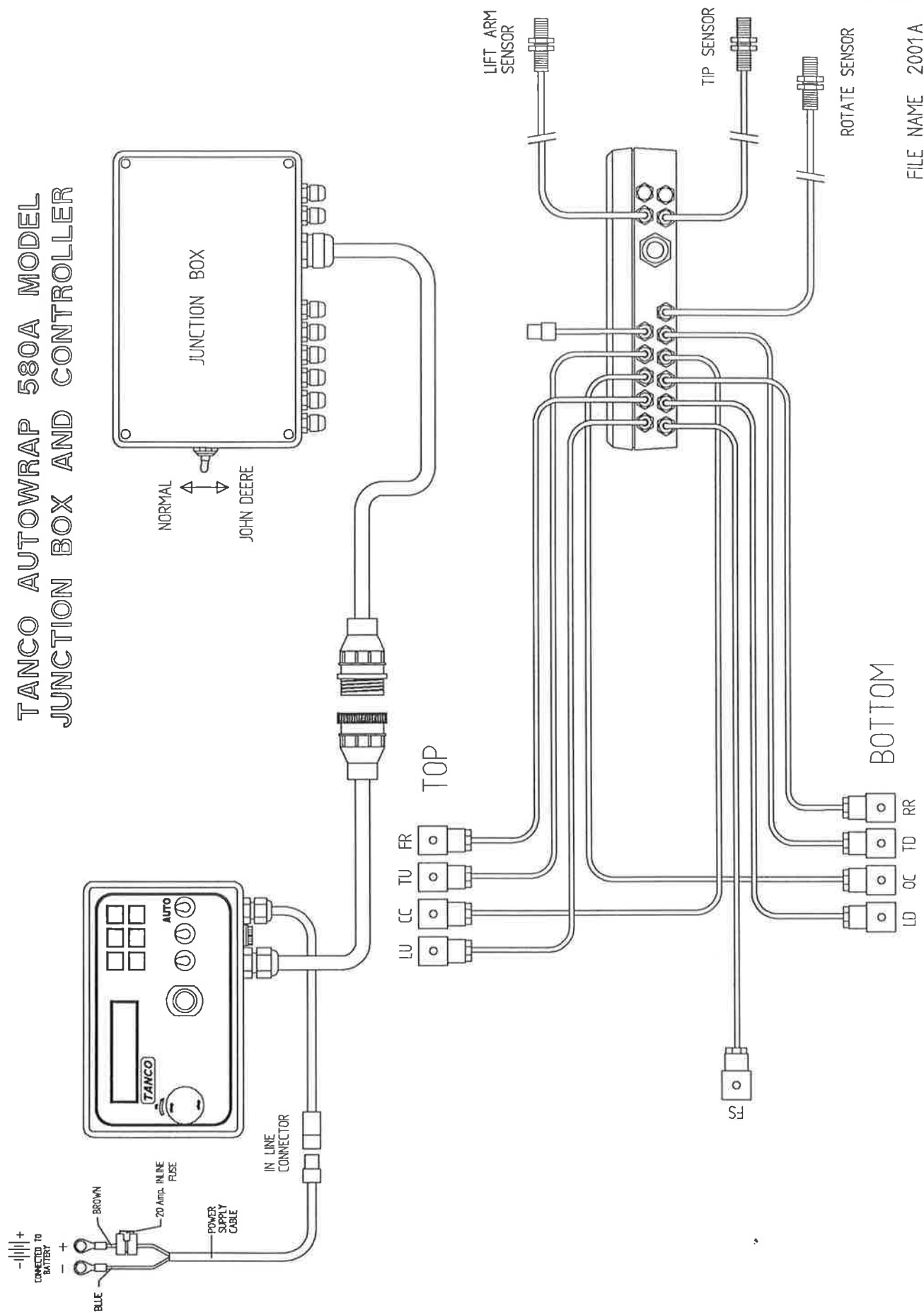


# Electrical circuit Diagram for Tanco 580S wrapper



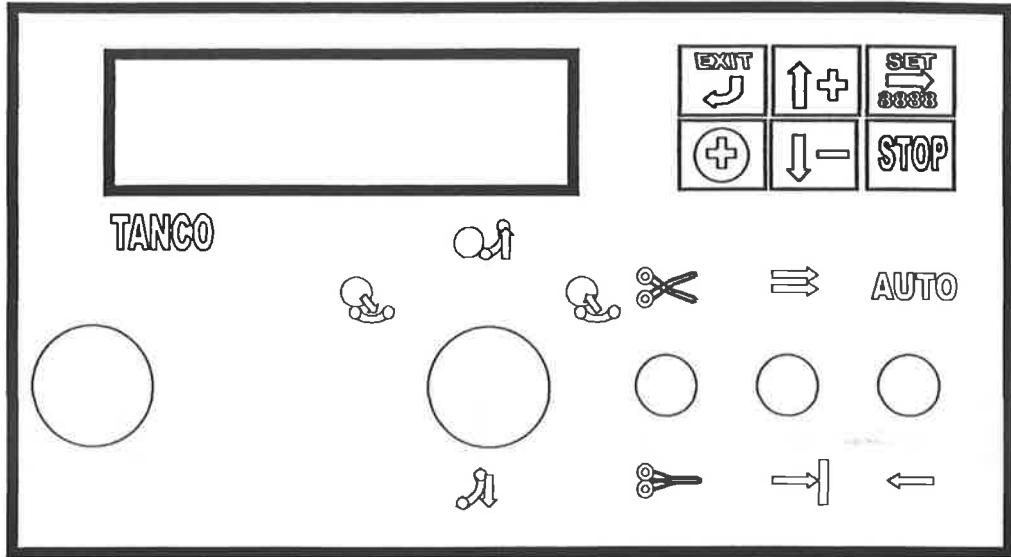


# TANCO AUTOWRAP 580A MODEL JUNCTION BOX AND CONTROLLER

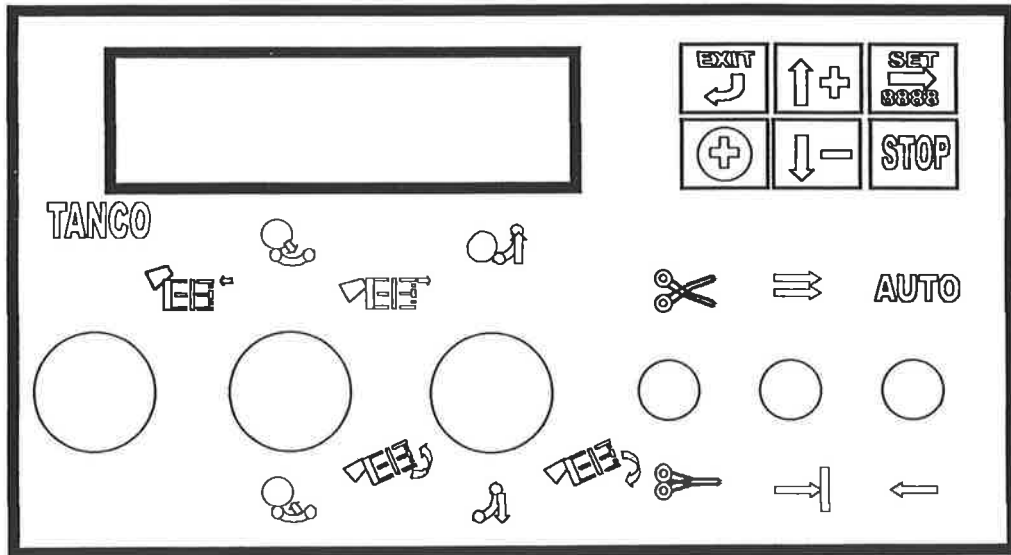


FILE NAME 2001A

### 580A controller version






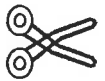







### 1080A controller version.







The TANCO wrapper machine controller is an advanced automatic system. It both control and monitors the moving machine parts and thereby provides for an optimal efficient and safe machine operation. The system gives detailed instructions and messages via the 40 character alphanumeric display, enabling the operator to monitor the operation of the wrap machine at any instant.

The system is equipped with various test facilities, warning messages, error messages and instructions making the system superior in terms of facilities, service and operation.


## THE DISPLAY UNIT AND PANEL FUNCTIONS

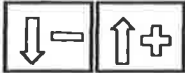


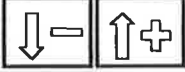


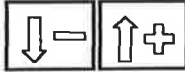
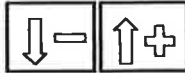
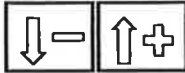
SWITCH FUNCTIONS	EXPLANATION.
Fig1 	Tip off the bale on manual instruction.
Fig2 	Tip table back to horizontal on manual instruction.
Fig3 	Close cutter on manual instruction.
Fig4 	Open cutter on manual instruction.
Fig5 	Lower load arm on manual instruction.
Fig6 	Raise load arm on manual instruction.
Fig7 	Raise elbow on manual instruction ( 1080ATP only )
Fig8 	Lower elbow on manual instruction ( 1080ATP only )
Fig9 	Release bale on manual instruction ( 1080A only )
Fig10 	Grab bale on manual instruction ( 1080A only )
Fig11 	Turn table seek next position, for load or offload, with slow speed on manual instruction.




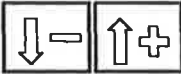


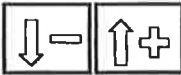


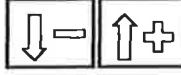
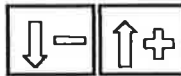
	<p>Turn table rotate fast on manual instruction. The turn table will start in slow mode, accelerate and decelerate to the slow mode before stopping. The turn table will stop in any position when the switch is released.</p>
<p>Fig13</p> 	<p>Turn table rotate slow in reverse on manual instruction. The turn table will stop in any position when the switch is released.</p>
<p>Fig14</p> <p style="text-align: center;">AUTO</p>	<p>Auto start the wrapping cycle. The “auto” command will start the wrapping cycle at a point defined in the program setting. This point may be set to, load bale automatically or start the cycle after the bale loaded automatically or wait for auto command when the bale is loaded. When the turntable is running, an auto command will shorten the program cycle, decelerate on the next passing of the offload position and stop on the following complete turn. This cycle is considered completed.</p>
<p>Fig15</p> 	<p>Depressing STOP will stop the cycle at any point in the cycle. An auto command will restart the cycle without any disturbance of the program cycle and maintain status of all functions operated manually between the stopping and the restarting of the cycle.</p>
<p>Fig16</p> 	<p>Depressing this button provides for the possibility to increase the required number of table turns for the cycle in progression. Each push will increase the turns by one for that cycle only.</p>

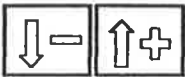

**THE DISPLAY MENUES.**

At the operator level there is a number of menus enabling the operator to perform various tests and adjustments to the machine operation. Should adjustments of parameters that not are accessible to the operator be required, please contact the TANCO dealer or TANCO.

DISPLAY INDICATION	FOR NEXT VIEW DEPRESS	DESCRIPTION.
<p>WRAP CYCLE 15: 20 0</p> <p>BALES: 1 324</p>		<p>The operative display that shows the commonly most needed information. The number 15 indicates the actual number of turntable revolutions at this moment. The number 20, is the preset number of turntable revolutions required to wrap the bale.</p>

DISPLAY INDICATION	FOR NEXT VIEW DEPRESS	DESCRIPTION.
<p><b>ACTUAL RPM 29</b> <b>ALARM LIMITS: 16 - 30</b></p>		<p>The 16 - 30 indicate the programmed limits of the turntable speed. Should the speed exceed 30 rpm or fall below 16 rpm, the audio alarm will be engaged and the display will show this message. The Actual RPM shows the wrapping speed at any given instant.</p>
<p><b>BALE COUNTERS</b> <b>PRESS SET TO ENTER</b></p>		<p>The system has all in all 10-bale counters. When entering this display, it is possible to inspect: Total (sum of all bale counters.) Machine total (the sum of all bales ever made on the machine. This is not a reset able value.)</p>
<p><b>BALES TOTAL:</b> XXXXX <b>MACHINE</b> <b>TOTAL: XXXXX</b></p>		<p>Bales total. As below but a reset able function. Machine total displays the total quantity of bales made on the machine in total. This is not a reset able function.</p>
<p><b>COUNTER:</b> 1:XXXX 2:XXXX 3:XXXX</p>		<p>Each counter display contains 3 counters.</p>
<p><b>COUNTER:</b> 4:XXXX 5:XXXX 6:XXXX</p>		<p>Each counter display contains 3 counters</p>
<p><b>COUNTER:</b> 7:XXXX 8:XXXX 9:XXXX</p>		<p>Each counter display contains 3 counters</p>
<p><b>WORKING HOURS: 123</b> <b>MACHINE TOTAL: 798</b></p>		<p>Displays the number of working hours of the machine in 1 week, day or other. ( reset able ) and the total number of the machine operating hours. ( not a reset able facility.)</p>
<p><b>SETUP ( 580A,TRAILED )</b> <b>PRESS SET TO ENTER</b></p>		<p>The operator may here change some parameters relating to the machine in order to alter the machine cycle, sensor setup, hydraulic flow table selection and other different options.</p>
<p><b>WELCOME TO SETUP!</b> V</p>		

DISPLAY INDICATION	FOR NEXT VIEW DEPRESS	DESCRIPTION.
AUTO-LOAD BALE WITH LOAD ARM: No		A no Statement the operator must operate Loading Arm with Joystick.
AUTO -LOAD BALE WITH LOAD ARM : YES		A YES statement will when a bale is located on the load arm with the load arm in the standby position upon a AUTO start command cause the bale to be loaded onto the table and start the wrap cycle
ROTATE 90 DEGREES AFTER TIP FORWARD TO SENSOR: YES		Defines the loading position 90 degrees counter clockwise to the offloading position.
ROTATE 90 DEGREES AFTER TIP:NO		Defines the loading and off loading position. To be the same turn table position.
SENSOR SETUP. PRESS SET TO ENTER.		Entering the sensor setup level.
CUT NOW SENSOR INSTALLED: YES		The film cutter will be activated upon signal from this sensor.
ROTATE LOAD-POSITION SENSOR INCLUDED:NO		Defines if there is a load position sensor installed.
LOAD ARM UP/DOWN SENSOR INCLUDED : YES		In order to achieve automatic loading of the bale a load arm sensor is required installed.
HARDWARE TEST PRESS SET TO ENTER		The hardware test program is a tool facility enabling and guides the operator and service people to test and inspect almost all functions, switches, sensors and push buttons on the system. It also contains a battery supply voltmeter which automatically will be displayed should the voltage drop below 8 volt during the operation.
SUPPLY VOLTAGE:xx.xV LAST DROP: xx.xV		Displays the instantaneous battery supply loaded and off load. The last drop is the lowest voltage supply measured during current surge when activating the hydraulics.
SENSOR (input) TEST. PRESS SET TO ENTER		Entering the sensor / digital input test facility.

<p>LOAD ARM DOWN, No: 16:0 CUT /HORIZONTAL, NO.17:0</p>		<p>20:0 MEANS TERMINAL OR PIN NUMBER 10 , 0 MEANS INACTIVE. WHEN ACTIVE THE STATUS CHANGES TO 20 : 1</p>
<p>ROTATE ( TIP).NO.18:0 INFRA RED REC.NO.19:0</p>		
<p>TEST KEYS PRESSED: XXX.XXX</p>		<p>Enables the testing of each push button on the control panel.</p>
<p>TEST SWITCHES ACTIVATED:XXXX.XXXX.XX</p>		<p>Enables the testing of each function switch on the control panel.</p>
<p>TEST RELAYS, 0=OF XXXXX.XXXXX.XXXXX (12)</p>		<p>Enables the testing of each relay output function for the hydraulics on the controller</p>
<p>TEST. IR REMOTE CONTROL: 00 00 00 00</p>		<p>Enables to test the Ir receiver and transmitter functions.</p>

Operating modes.

The system is designed so that the automatic mode and the manual mode are separated with a STANDBY MODE. This means that when operated in the automatic mode, all manual commands are ignored with the exception of the function button for the application of additional turntable revolutions and the stop button. This also gives the advantage of interrupting and restarting the cycle at any instant without the system losing track of the cycle state. All functions may be manually operated and are only accessible when in standby mode.

All safety criteria are active in both the manual and automatic operation.

STANDBY MODE.

Standby mode is the waiting state between the automatic mode and the manual mode. Standby mode is automatically resumed when:

1. An automatic cycle is completed.
2. Between cycle steps, Example: The wrapping cycle is completed and the system announces that it is ready to offload the bale. *It is here in STANDBY for an operator command* for manual or automatic function. An AUTO command will here instruct the machine to advance to the next logical step in the auto cycle, loading, offloading or start wrapping.
3. Stopping the cycle at any stage will bring the system into standby mode.

MANUAL MODE.

The manual mode is accessed by activating one of the manual functions switched when the machine is inactive (standby mode). Any machine function is accessible provided that it is a “ legal “ operation. If the operator requests an illegal function such as offloading a bale while the turn table is incorrectly positioned, the system will refuse to perform the operation and state in the display the reason for the refusal, enabling the operator to correct the machine status before the requested function can be made active.

AUTOMATIC MODE.

The machines are generally operated automatically during the actual wrapping cycle to the offloading stage. The controlling system will with its standard factory settings, automatically control the machine with AUTO commands given on the AUTO switch by the operator. For every program step, the machine has completed, the machine will stop and wait for further instructions from the operator.

Upon the completion of a wrapping cycle, the system will via the audio alarm and display, inform the operator that the wrapping cycle has now been completed (program number is equal to actual number of turntable revolutions, e.g. 16: 16). Now yet an AUTO command will offload the bale.

SETTING UP THE SYSTEM:



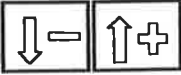




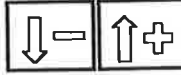

All functions are pre-adjusted from the TANCO factory and commonly the only required adjustment is the turntable revolutions required.

**CYCLE PROGRAMMING.**

1: Programming the required number of turntable revolutions. (changing from 20 to 25 turntable revolutions.)

7

2: Choosing 1 of the 9 Bale counters.

DISPLAY INDICATION.		DESCRIPTION.
WRAP CYCLE 0: <u>20</u> 0  BALES : 1                    324	  	<p>To enter programming mode, push and hold the SET button for 1 second. The highest value in the program number will now flash, meaning that it may now be changed. As the number is to be changed from 20 to 25 turntable revolutions the number 2 is not required changed therefore push "SET" again to make the lowest number value flash. (eg. "0")</p>
WRAP CYCLE 0: <u>25</u> 0  BALES : 1                    3 2 4		<p>Pushing MENU UP will increase the number value between 0 and 9. Similarly MENU DOWN will reduce the number value between 9 and 0. In this case push MENU UP 5 times to change the number from 0 to 5. Now the required turntable revolutions will read 25.</p>
WRAP CYCLE 0: 25 0  BALES : <u>1</u> 324	    	<p>To exit programming of required turntable revolutions, push the EXIT button. The bale counter number ( in this case counter number 1 ), will flash and the counter number is now changeable. The unit contains 9 individual counters and 1 counter for the sum of bales. The MENU UP or DOWN key is used to change the number. If the same counter is to be used push EXIT again.</p>
WRAP CYCLE 0: 25 0  BALES : 2                    125	    	<p>It is shown that the counter chosen, is counter number 2. This counter contains a quantity of 125 bales, stored in the memory. If it is required to continue the bale counting from this quantity and onwards, push EXIT to return to operative mode, or ZERO the counter on the MENU up or DOWN key and then EXIT to return to operative.</p>

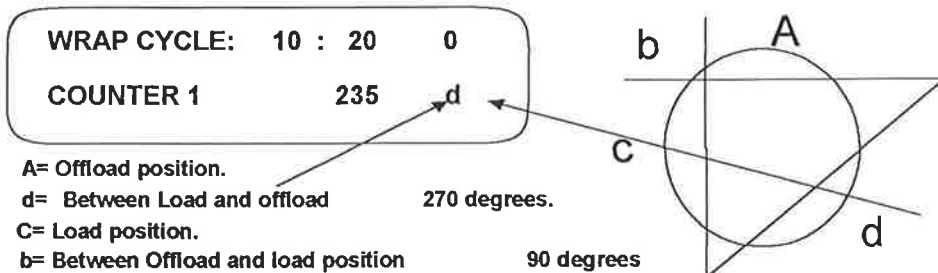
**A TYPICAL WRAP CYCLE .**

When work begins the machine is normally transported with the LOADING ARM parked in the vertical position. The computer registers the lifting of the loading arm as the loading of a bale. Therefore the display will show that a bale is now located on the table. **Therefore the system will commence wrapping around an empty table, if the AUTO switch is activated when the loading is down. Therefore it is important that the loading arm is lowered using the joystick and the first bale in the first work cycle is loaded manually only.**


Provided the table remains in the loading position ( C position on display ), the system allows the full up and down movement of the loading arm, however if the system states there is a bale on the table, movement in the upwards direction will be stopped on the load arm sensor and lifting the loading arm further is only possible on the 2<sup>nd</sup> attempt.



DISPLAY.



Loss of orientation may occur if the controller suffers power loss during a wrap cycle and the power loss occurs less than 3-4 revolutions before the cycle is completed. If there are 2 or more fast speed revolutions left of the cycle, the system will automatically regain the orientation.

In case of loss of orientation, less than 3-4 revolutions before the end of the wrap cycle, the table will then stop in Loading position. Now activate the positioning switch  to bring the Turntable into the offload position and manually offload the bale. Now tip the table to horizontal Position. The system now shows the correct position (A) on the display and will now seek load position ( C ) on the next auto start command.

**ERROR MESSAGES ON THE DISPLAY.**

The machine will in all cases monitor the status of the moving machine parts. Should the expected position or status of a sensor or device not comply with the safety requirements specified in the software program, the system will stop the machine cycle at the point where an error has occurred or when the operator requests an illegal or hazardous command. It will then via the display announce the reason for the command refusal. When restarting the machine the system will memorize the point where the cycle was interrupted and continue from the point where it stopped.

### EXAMPLE:

A bale has been wrapped in the manual mode. The operator stops the wrapping cycle with the turntable away from the offload position. Now if an offload command then is given, the system will via the display announce that this is an illegal command, writing **TABLE NOT IN OFFLOADING POSITION..**”

**TABLE NOT IN  
OFFLOADING POSITION**

In order to bring the machine into the correct status the operator must then using the manual TABLE position command to bring the system back to the logical sequence state.

Similarly if a manual wrap cycle is requested and the table is not horizontally positioned, the display will write that the table is not lowered to the horizontal position.

### LOADING A SECOND BALE ONTO THE LOAD ARM WHILE WRAPPING.

When loading a bale onto the turntable, and an auto start command is given, the load arm will automatically return to STANDBY position and the wrapping cycle will automatically begin if the setup defines this. See SETUP, (AUTO LOAD BALE WITH LOAD-ARM: YES / NO). During an auto cycle the operator has permanent manual access to operate the load arm within limits defined in the program. When the operator approaches the 2nd bale and the load arm is lowered to standby position to collect the 2nd bale, the load arm sensor is activated. When lifting the bale and the loading arm reaches the STANDBY position., the loading arm sensor will deactivate the load arm lifting function, preventing collision with the turntable.

After the bale in process is completed an AUTO command will tip off the bale and when the table again is horizontal, yet an AUTO command will load the new bale from the loading arm onto the table, again provided the system is defined to (AUTO LOAD BALE WITH LOAD-ARM: YES)

### VERY IMPORTANT.

**It is not recommended that the loading arm is operated during a table tipping down operation, as there is speed priority on the loading arm causing all other functions to go ½ speed. This may cause the table not to return completely to horizontal position after the off loaded of the bale.**

### TROUBLE SHOOTING.

The system **HARDWARE TEST PROGRAM** is an operator accessible test facility. Combined with the display messages, it makes trouble shooting a less complicated matter. It contains the following:

1. Build in voltmeter that currently is monitoring the battery supply voltage from the tractor battery.

The voltmeter will simultaneously display:

- A. The instantaneous battery voltage (on load and off load)
- B. The most resent voltage ( lowest voltage ) caused by activating the hydraulics.

## 2 SENSOR STATUS.

This program enables the operator to test the individual sensors or sensor inputs and is found in the hardware test program. An active sensor will produce a "1" indication where an inactive sensor will produce a "0" statement. The display also states the terminal number of the sensors.

Use the MENU – button to locate the below display.

**HARDWARE TEST  
PRESS SET TO ENTER**

DEPRESS

**SET**  
→  
**8888**

**SUPPLY VOLTAGE 12,5  
LAST DROP 8,3**

DEPRESS ↓ – SEVERAL TIMES TO FIND THE DISPLAY

**SENSOR TEST ( input )  
PRESS SET TO ENTER**

**SET**  
→  
**8888**

**LOADARM DOWN No. 16, 0  
CUT/HORIZONTALNO.17,1**

## 3. TESTING THE CONTROL PANEL PUSH BUTTONS.

When the display below is shown, an activation of the function select buttons will cause the display to write which button is pushed. The menu and programming buttons maintains their original purpose and the only button which will show a status change are the set, stop and "reset / extra film layer buttons".

## 4. TESTING THE OPERATION SWITCHES.

When the display below is shown, an activation of the operation switches and Start switch will cause the display to write the status change of the function switches activated.

Use the MENU – button to locate the below display.

**HARDWARE TEST  
PRESS SET TO ENTER**

DEPRESS



**SUPPLY VOLTAGE 12,5  
LAST DROP 8,3**

DEPRESS ↓ – SEVERAL TIMES TO FIND THE DISPLAY

**TEST SWITCHES ACTI-  
VATED: 00000000**

#### 5.RELAY OUTPUT STATUS ( amp pin output.) :

The relay output status: Indicates which hydraulic valves should be active when any operation is commanded. The operator / serviceman will from this information able to determine whether there's a hydraulic or electrical defect. The status of the output is shown as a "1" for active and a "0" for inactive. The status of the output is shown as the pin number in the AMP connector and the terminal number in the termination box.

Depress the key ↓ – several times until the display below is shown.

**HARDWARE TEST  
PRESS SET TO ENTER**

DEPRESS



**SUPPLY VOLTAGE 12,5  
LAST DROP 8,3**

DEPRESS ↓ – SEVERAL TIMES TO FIND THE DISPLAY

**TEST RELAYS  
1030.0000.0AB0.000**

When testing a function e.g. Table rotate, a number of outputs are activated simultaneously as other devices usually are required activated at the same time such as the beacon and slow speed during the start of the wrapping cycle. In the above example the loading arm down function is active. The output no 1 is the Two speed valve ( high speed ), 3<sup>rd</sup>. output is the load arm down function, A ( terminal output No.10 ) is the beacon and B (No. 11 ) is the JD. Output terminal.

Below it is shown which relays, the AMP pin numbers and terminal numbers are related to.

Amp pin no1. and term. no.1	Amp pin no.2 and term. no.2		Amp pin no.3 and term. no.3	Amp pin no.4 and term. no.4	Amp pin no.5 and term. no.15	
Two Speed valve	Load arm down		Load arm up	Table forward	Table reverse	
Amp pin no 6, 16and term. no 6.	Amp pin no7, 17and term. no 7.		Amp pin no.8 and term. no.8	Amp pin no.9 and term. no.9	Amp pin no.10 and term. no.10	
Cutter open	Cutter close		Off load	Tip to horizontal	JD valve	
Amp pin no.11 and term no11	Amp pin no.12 and term no.12	Amp pin no.13 and term. no. 13	Amp pin no.14 and term no.14	Amp pin no.15 and term no.15	Amp pin no.16 and with no.6	Amp pin no.17 and with no.7
Rotor lamp	close grab	Open grab	wrist up	wrist down	Cut close	Cut open

**WIRING / TERMINATION / AMP PIN AND FUNCTION TABLE.**

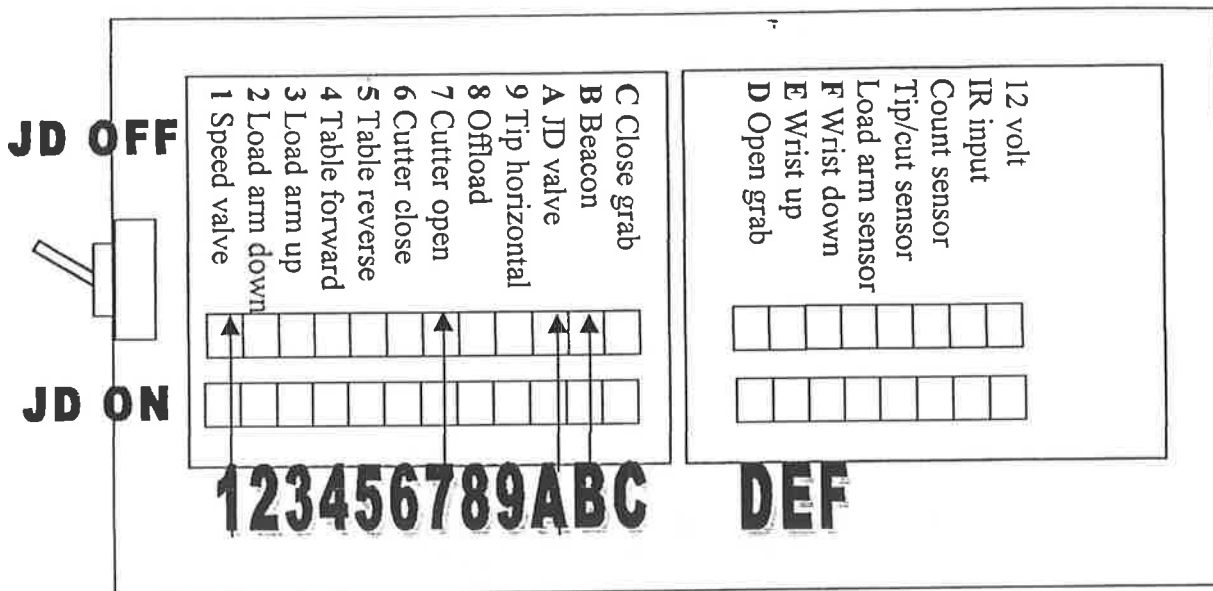
<b>Wire and AMP number</b>	<b>Terminal number</b>	<b>Input &amp; output function</b>
1	1	Table slow/fast
2	2	Load arm down
3	3	Load arm up
4	4	Table forward
5	5	Table reverse
6&16	6	Cutter close
7&17	7	Cutter open
8	8	Tip up
9	9	Tip down
10	10	JD valve
11	11	Beacon
12	12	Close grab
13	13	Open grab
14	14	Elbow up
15	15	Elbow down
16&6	6	Cutter open
17&7	7	Cutter close
18		Ground
19	16	Infra-red sensor signal
20	17	Tip/cut sensor
21	18	Rotate tip position sensor
22	Ground	Ground
23	19	Load-arm sensor
24	20	12 volt for Infra-red receiver

**TESTING INDIVIDUAL FUNCTIONS.**

When testing a function for example turntable rotate, a number of outputs are activated simultaneously. Also other devices are usually required activated at the same time such as the beacon, JD and the speed valve for all functions except when wrapping slow at the start of the wrapping and when the loading arm is raised or lowered during the wrapping cycle.

<b>FUNCTIONS ACTIVATED ON CONTROL PANEL.</b>	<b>DISPLAYSHOWS ACTIVATED TERMINALS</b>  ( terminal 1234.5678.9ABC.DEF )
<b>turn table fast forward</b>	( terminal 1000.0000.0AB0.0000 )
<b>load arm down</b>	( terminal 1200.0000.0AB0.0000 )
<b>load arm up</b>	( terminal 1030.0000.0AB0.0000 )
<b>turn table slow forward</b>	( terminal 0004.0000.0AB0.0000 )
<b>turn table slow reverse</b>	( terminal 0000.5000.0AB0.0000 )
<b>cutter close</b>	( terminal 1000.0600.0AB0.0000 )
<b>cutter open</b>	( terminal 1000.0070.0AB0.0000 )
<b>tip up</b>	( terminal 1000.0008.0AB0.0000 )
<b>tip down</b>	( terminal 1000.0000.9AB0.0000 )
<b>JD/ general valve</b>	( terminal 0000.0000.0X00.0000 )
<b>rotor lamp</b>	( terminal 0000.0000.00X0.0000 )
<b>close grab</b>	( terminal 1000.0000.0ABC.000 )
<b>open grab</b>	( terminal 1000.0000.0AB0.D00 )
<b>wrist up</b>	( terminal 1000.0000.0AB0.0E0 )
<b>wrist down</b>	( terminal 1000.0000.0AB0.00F )

**TERMINATIONS**



The cutter open function requires that terminals 1,7,A AND B, present 12-volt on their respective outputs when the function is active. Note that the A terminal is the JD function with an inverted output, meaning that the terminal when inactive presents 12 volt on the terminal and is ground when active.

**THE SENSORS AND THEIR PURPOSES**

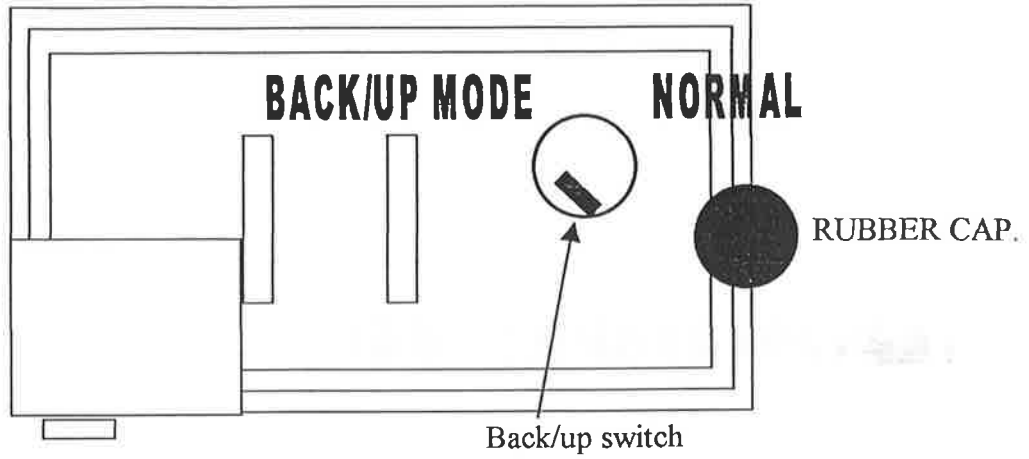
In the user level the sensor setup section is located, here a defect sensor may be disengaged which otherwise would make it impossible work continue.

<b><u>SENSOR NAME</u></b>	<b><u>SENSOR FUNCTION</u></b>
<b>Load arm sensor</b>	Determines when it is safe to load the bale onto the table and commence the wrapping cycle.
<b>turn table sensor, (load and offload positioning )</b>	Determines the correct position of the turntable for loading and offloading. It also counts the number of applied turntable revolutions and monitors the speed of the wrapping cycle.
<b>Film cut sensor</b>	Governs the correct angular position of the table for the cutting the film when offloading the bale.
<b>Infrared sensor.</b>	Wireless operation of the machine. Typical operating distance is 30-meter or more. The rotor-lamp time delay engages automatically when receiving signals from the transmitter and is only active when using this facility
<b>Important. !</b>	The sensors installed on the machine, should under all normal circumstances always be engaged to ensure the safe operation of the machine. The sensor engage / disengage facility is only to be used in case of a sensor defect, enabling the continuous operation.

**BACK/UP MODE**

In the event of break down of the controlling circuitry, it is possible to operate the system in backup mode, bypassing the actual controller, enabling the continuing work.

**Computer rear view.**



**1:** Disconnect the power

**2:** Remove the rubber cap

**3:** Switch from right to left position

The display will now show

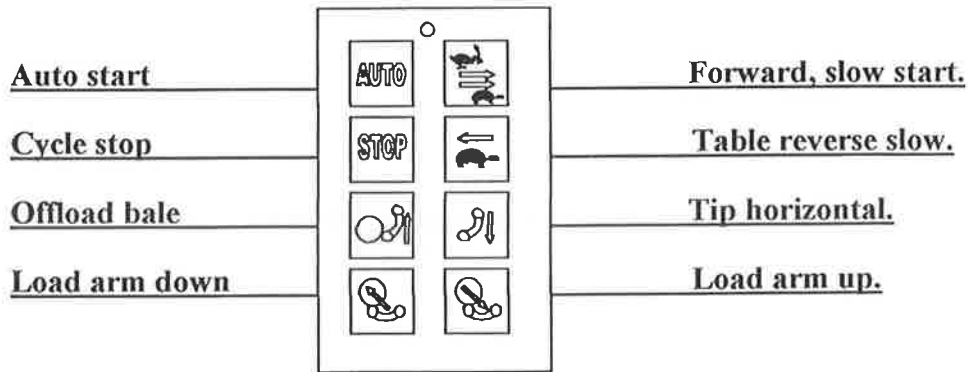
**"SWITCHED TO"  
"MANUAL MODE"**

provided the processor is working

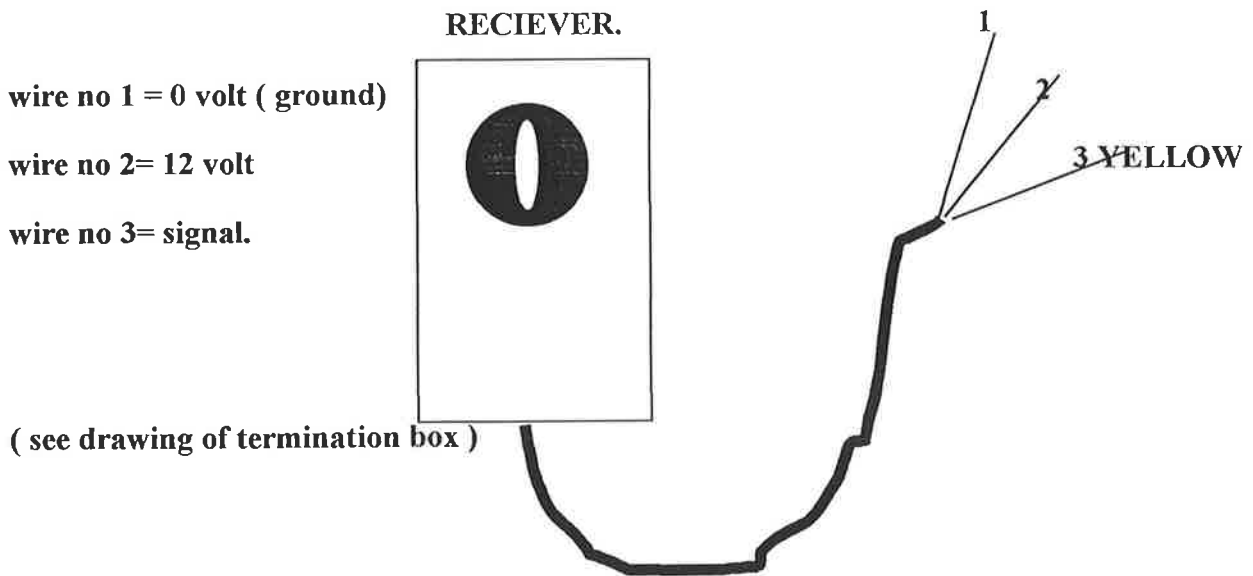
**THE INFRA-RED SYSTEM**

The operational radius of the system is typically 30 to 60 meters, depending on whether conditions and the state and type of battery used. Worst situations are early morning sunshine and at sundown, where 20 meters can be expected.

**Further!** Tractors may be equipped with UV filtered windscreens also reducing the radius of the system



**Warning!** The AUTO function on the handset, will start the machine with equal conditions to those, when using the AUTO command on the actual controller panel.



**DISPLAY ERROR MESSAGES.**

**DISPLAY MESSAGE EXPLANATION.**

<p><b>VOLTAGEDROP</b> <b>TO:xx.xV</b></p>	<p>The load provided by the hydraulic circuit has caused the supply voltage to drop to a level below the acceptable limit. ( 8 volt.)</p> <ol style="list-style-type: none"> <li>1. The tractor generator may be defect.</li> <li>2. The tractor engine Rpm may be too low for the generator to charge the battery.</li> <li>3. The supply cable termination onto the battery may be poor or dirty.</li> <li>4. The batter may be defect.</li> </ol> <p>Check terminations and go to the hardware test program to inspect the battery supply voltage in unloaded condition and loaded condition.</p>
<p>(any message plus )</p> <p><b>TIMEOUT!</b></p>	<p>Indicates that an associated hydraulic function has not been activated on the controller command. A timeout message means that a sensor has not received an expected signal within a defined period.</p> <ol style="list-style-type: none"> <li>1. The valve may be defect or hanging.</li> <li>2. The relay output may be defect.</li> <li>3. The Hydraulic connector may have fallen off.</li> <li>4. The cable may be broken.</li> <li>5. The hydraulic connector may be defect.</li> <li>6. The sensor is defect, test sensor using test program.</li> </ol> <p>Test that the output supply is available on the associated terminals, Amp pins and hydraulic connector.</p>
<p><b>NO ROTATE PULSES</b></p>	<p>Check that the turntable is rotating, if it does check the sensor and it's wiring, if ok, use the same procedure as with timeout message.</p>
<p><b>LOAD ARM NOT DOWN</b></p>	<p>As above.</p>
<p><b>OTHER MESSAGES MAY APPEAR AND SHOULD BE TREATED AS THE ABOVE ILLUSTRATED</b></p>	

**OVERALL VIEW OF DISPLAYS, VARIABLES AND FACILITIES.**

<b>OPERATOR LEVEL</b>	T
<b>ENGLISH.</b>	<b>ENGLISH</b>
<b>DISPLAY EXPLANATION.</b>	<b>DISPLAY</b>
<b>USER SECTION ONLY</b>	
Programmable user cycle. Counter 3 are the bale counter in use at present.( 580A)	WRAP CYCLE: 0-16 / BALECOUNTER 3: 345 X
Programmable user cycle. Counter 3 are the bale counter in use at present.( 1080A)	WRAP CYCLE: 0-20 / BALECOUNTER 3: 345 X
The speed of the turntable is here monitored at any instant. Should the speed fall below or increase above the limits, audio and visual alarm will sound.	ACTUAL RPM: 22 (ALARM LIMIT: 20-35)
The system contains a total of 10 bale counters, which the operator is free to choose from. The individual counters are reset able.	BALE COUNTERS. Press SET to enter.
The operator setup level provides the operator with the possibility to make minor changes to the machine cycle.	SETUP PRESS SET TO ENTER.
<b>ENTERING THE BALECOUNTER PROGRAMMES</b>	
Bales total. As below but a reset able function. Machine total displays the total quantity of bales made on the machine in total. This is not a reset able function.	BALES TOTAL: XXXXX MACHINE TOTAL: XXXXX
Each counter display contains 3 counters.	COUNTER: 1:XXXX 2:XXXX 3:XXXX
Each counter display contains 3 counters	COUNTER: 4:XXXX 5:XXXX 6:XXXX
Each counter display contains 3 counters	COUNTER: 7:XXXX 8:XXXX 9:XXXX
<b>USER ACCESABLE SETUP LEVEL</b>	<b>USER ACCESABLE SETUP LEVEL</b>
<b>Entering the user setup level.</b>	<b>PRESS SET TO ENTER.</b>
	WELCOME TO SETUP! V

<p>A YES statement will when a bale is located on the load arm with the load arm in the standby position upon a AUTO start command cause the bale to be loaded onto the table and start the wrap cycle</p>	<p>AUTO LOAD BALE WITH LOAD-ARM: NO</p>
<p>Defines the loading position. (3-point linkage or trailed machine.)</p>	<p>ROTATE 90 DEGREES AFTER TIP.</p>
<p>Entering the sensor setup level.</p>	<p>SENSOR SETUP. PRESS SET TO ENTER.</p>
<p>The film cutter will be activated upon signal from this sensor.</p>	<p>CUT NOW SENSOR INSTALLED: YES</p>
<p>Defines if there is a load position sensor installed.</p>	<p>ROTATE LOAD-POISITION SENSOR INCLUDED:NO</p>
<p>In order to achieve automatic loading of the bale a load arm sensor is required installed.</p>	<p>LOAD ARM UP/DOWN SENSOR INCLUDED : YES</p>
<p>Entering the hardware test program.</p>	<p>HARDWARE TEST PRESS SET TO ENTER.</p>
<p>Displays the instantaneous battery supply loaded and off load. The last drop is the lowest voltage supply measured during current surge when activating the hydraulics.</p>	<p>SUPPLY VOLTAGE:xx.xV LAST DROP: xx.xV</p>
<p>Entering the sensor / digital input test facility.</p>	<p>SENSOR (input) TEST. PRESS SET TO ENTER</p>
<p>20:0 MEANS TERMINAL OR PIN NUMBER 10 , 0 MEANS INACTIVE. WHEN ACTIVE THE STATUS CHANGES TO 20 : 1</p>	<p>LOAD ARM DOWN,NO: 16:0 CUT /HORIZONTAL, NO.17:0</p>
<p></p>	<p>ROTATE ( TIP).NO.18:0 INFRA RED REC.NO.19:0</p>
<p>Enables the testing of each push button on the control panel.</p>	<p>TEST KEYS PRESSED: XXX.XXX</p>
<p>Enables the testing of each function switch on the control panel.</p>	<p>TEST SWITCHES ACTIVATED:XXXX.XXXX.XX</p>
<p>Enables the testing of each relay output function for the hydraulics on the controller</p>	<p>TEST RELAYS, 0=OF XXXXXX.XXXXXX.XXXXXX (12)</p>
<p>Enables to test the Ir receiver and transmitter functions.</p>	<p>TEST. IR REMOTE CONTROL: 00 00 00 00</p>
<p><b>OPERATOR LEVEL END.</b></p>	<p><b>OPERATOR LEVEL END.</b></p>
<p></p>	<p></p>

## MODE OF OPERATION

### Automatic Mode:

1. Ensure turntable is in correct position to accept bale and that film is gripped by the "Cut and Start".
2. Lower bale lift arm, drive alongside, pick up the bale and raise the lift arm.
3. Allow the bale to roll gently onto the turntable so that it is central between the end rollers.
4. Lower the arm clear of the turntable and press the "Auto" button commence wrapping. NOTE: The table must be in the correct position before the "Auto" button is pressed.
5. With the controller in Automatic Mode the turntable will start off for half of one rotation in "Slow Mode" before changing to "Fast Mode". During the final rotation it will change to "Slow Mode" and stop in the correct position so that the film is lined up above the open "Cut and Start". NOTE: The turntable can be moved to left or right to align the "Cut and Start" by using the Forward/Reverse rotate switch on the controller or the buttons on the remote control unit.
6. On the third rotation of the wrap cycle the "Cut and Start" will open automatically.
7. When in a safe position to do so, press the "Tip Up" button, the turntable will tip upwards gathering the film on the "Cut and Start" plunger whilst the pull down arm reduces the film to a rope which is cut as the "Cut and Start" closes, cutting the film and gripping the film end in readiness for the next bale.
8. The tip off sequence is automatic and once the turntable lowers it will rotate forward and stop in position to facilitate loading, if programmed to do so.

## OPERATING INSTRUCTIONS

1. Fit roll of film and thread through the Dispenser roller assembly by following the instruction label on the film mast.
2. Set the bale wrap indicator to the correct setting for the size of the bale being wrapped and the width of film being used see Table 1 for list of some recommended setting.
3. Power down Lift Arm until wheel is clear of ground and adjust wheel outward to appropriate setting for bale weight.
4. Adjust tractor engine speed to give turntable speed of 16 – 30 r.p.m. **NOTE:** Speeds in excess of 30 r.p.m will void warranty.
5. Position turntable with cut and start unit facing front of machine.
6. Attach film tag end to gripper section of cut and start unit.
7. Rotate turntable anticlockwise through 90 degrees and stop turntable with cut and start unit opposite to lift arm.
8. Locate bale on Lift arm, then raise lift arm and gently roll bale onto turntable. Lower arm.
9. Start wrapping, turntable rotating anticlockwise. Film tension is automatically set so that width of film applied to the bale stays at approx. width of 400mm for 500mm wide film roll and 600mm for 750mm wide film roll.
10. Continue wrapping until signal from bale wrap indicator sounds (required number of revolutions has been reached) then stop with cut and start unit facing towards front of machine and film aligned with gripper section of cut and start unit.
11. Tip bale from machine. When the machine is almost fully tipped the cut and start unit grips and cuts the film and the bale is then unloaded onto the bale ramp.
12. Lower the turntable and rotate anticlockwise through 90 degrees and stop with cut and start unit opposite to lift arm.
13. Repeat operation 7 – 12 as required.

**NOTE:** The film end need only be attached at the start of a roll, after that, the sequence is automatic.

## WARNING LIFT ARM

The Lift Arm on the trailed machine is designed to pick up and deposit bales onto the turntable prior to wrapping and to raise the machine while empty, to facilitate adjustment to sliding axle. It is not intended to be used for transporting bales over distances or for use as a stabiliser whilst wrapping.

Therefore, any use of the lift arm outside its primary function will be deemed to be abuse and will void all warranty.

## FILM,OVERLAP SYSTEM.

The Autowrap is fitted as standard with the 2 x 2 x 50% film overlap system. This is achieved by means of a chain drive which ensures that the correct number of film layers are applied to the bale after a specific number of revolutions of the turntable. The number of revolutions required to wrap a bale depends on width of film being used and bale size - See Table 1 below. The chain to be positioned on inner sprockets for 750mm wide film. Fig. A below.

For silage bales we recommend the application of a minimum of four layers of film.

Table 1

Bale Size	Width of Film Roll	Bale Indicator Setting (Revs)
120cm x 120cm	750mm	17
120cm x 137cm	750mm	19
120cm x 150cm	750mm	21

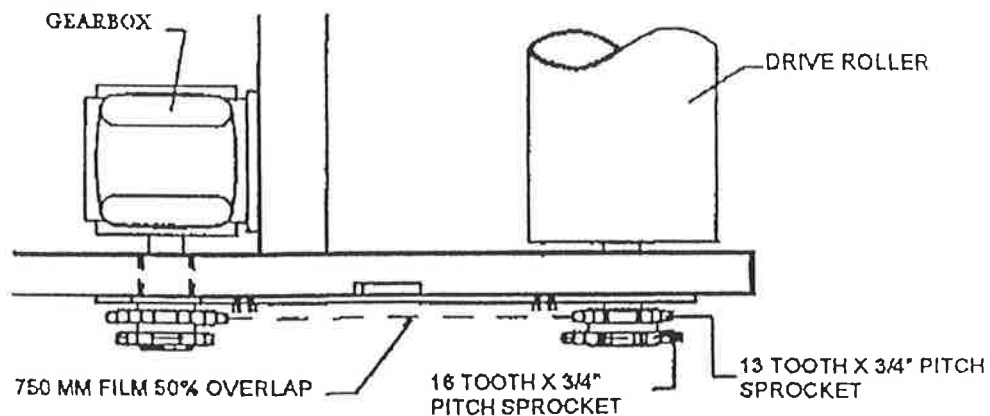


Fig. A

## IMPORTANT

The above recommendations are only offered as a guide to correct wrapping of silage bales and the manufactures accept no responsibility for variations that may arise and the consequence of same. They are based upon turntable speeds of up to 25 r.p.m., and a approx film width of 600mm applied to end bale when using 750mm wide film roll.

It is the responsibilitiy of the operator to ensure the correct number of wraps are applied, as variances can occur with fluctuations in speed of rotation, film quality and tensioning, shape and density of bale etc.

## SERVICE AND MAINTENANCE.

- 1: All nuts and bolts should be tightened after one hour 'm use and thereafter regularly.
- 2: Wheel pressure should be normally kept at 42 psi depending on bale weight and field conditions.
- 3: Inspect moving parts for wear on daily basis.

4: Lubrication.

Drive chain & sprocket	Grease every 24 hours.
Main rollers	Grease every 24 hours.
Hinge pins on Lift Arm	Grease every 24 hours.
Hinge pins on main tip frame	Grease every 24 hours
Hydraulic rams	Grease every 24 hours.
Film spoof assy	Grease every 24 hours.
Dispenser gearboxes	One shot of Grease every, 500 bales. See 6.
Main spindle	Grease even 4000-5000 bales.

5: Adjustments.

Turntable Drive chain:	Adjust after first days work then check/adjust every 50 hours. See Fig. 8
Gearbox Drive chain:	Adjust after first days work then check/adjust every 50 hours. See Fig. 2
Roller Drive chain:	Adjust after first days work then check/adjust every 50 hours. See Fig. 3
Main Bale Belt:	See belt tracking instructions.

6: Film Dispenser.

Apply P.T.F.E. based grease to gears every 2 to 3 months.

7: Film Adjustment.

Centre of film roll must be in line with centre of bale and film mast should be vertical.

## 8: Shear Pins

There are two shear pins fitted to sprocket assembly on drive roller see fig 5. If the pins shear, remove the broken pins re-align holes and fit two replacement spiral pins, 6mm dia x 20m long, Din 7344 There are two spare shear pins attached to inside of chain guard.

**NOTE:** If shear pins are replaced with other than specified above all warranty is null and void.

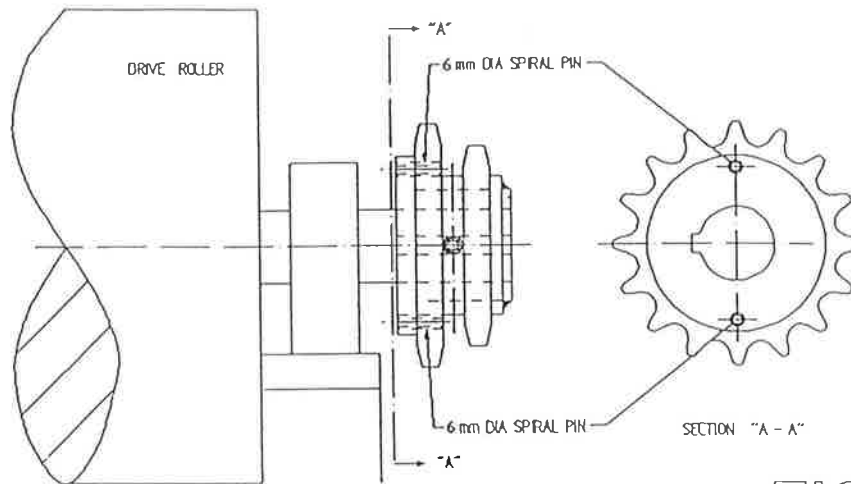
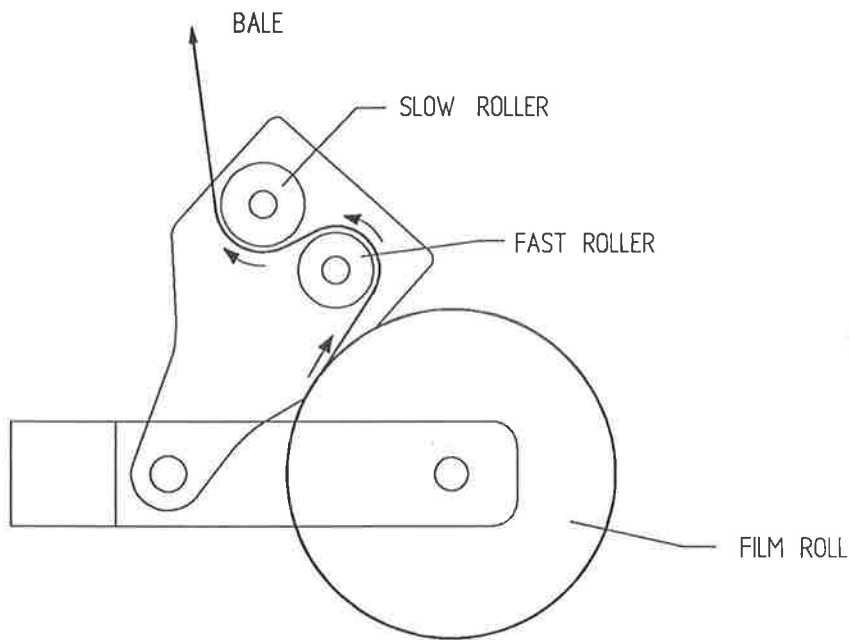


FIG. 5

## SERVICE AND MAINTENANCE (CNT.) HYDRAULIC FILTER

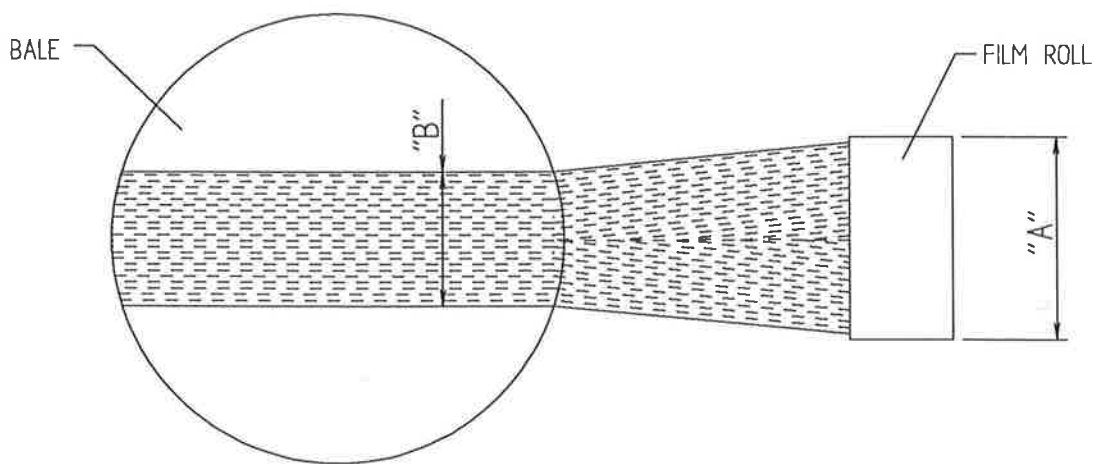
1. Before connecting Autowrap to tractor, change oil in tractor hydraulic system and replace hydraulic filter.
2. After 25 hours max. it will be necessary to replace the element in Autowrap filter.
3. For maintenance purposes it is necessary to change the element after 200 working hours.
4. The element cannot be just cleaned and put back into the filter.

# TANCO AUTOWRAP FILM THREADING DIAGRAM



## FILM ADJUSTMENT

CENTRE OF FILM ROLL MUST BE IN LINE WITH CENTRE OF BALE AND MAST SHOULD BE VERTICAL.

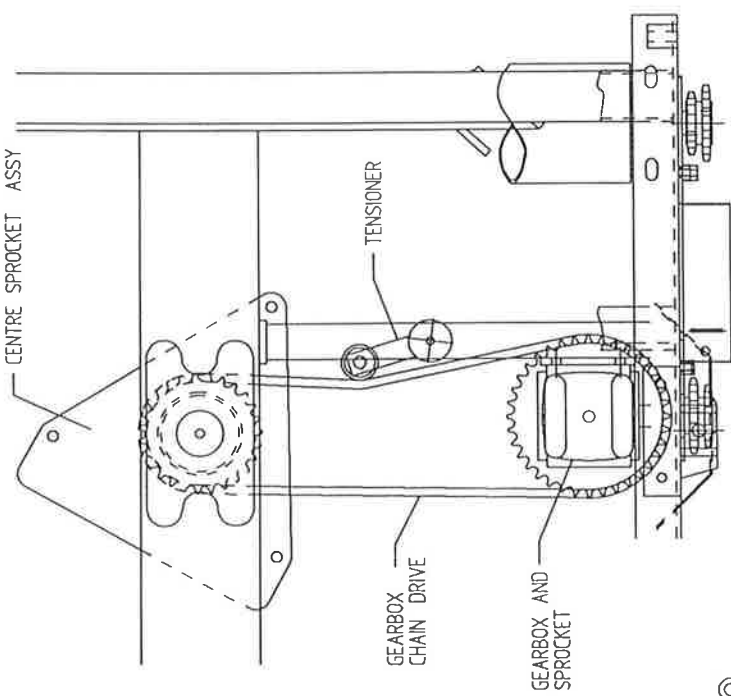


FILM ROLL WIDTH "A"	FILM WIDTH ON END OF BALE "B"
500 mm	400 mm
750 mm	600 mm

Fig. 1

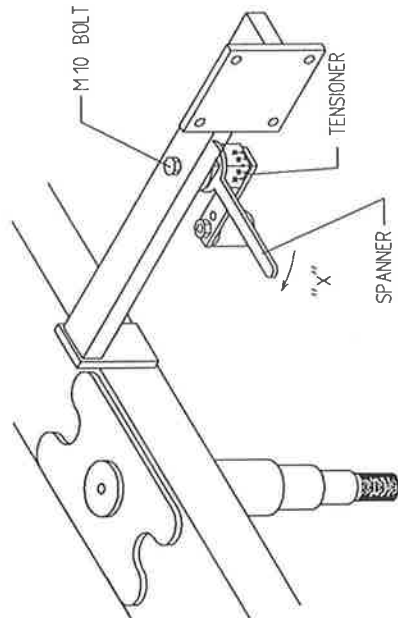
FILE NAME W060 - LA21

**TANCO AUTOWRAP CONSTANT INDEXING  
GEARBOX CHAIN DRIVE TENSIONING SYSTEM**

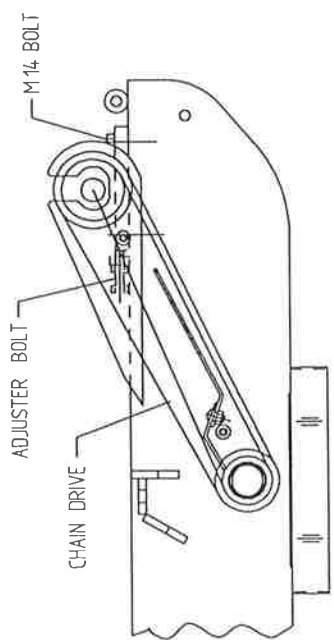


**Fig. 2**

- CHAIN TENSIONING PROCEDURE
1. LOOSEN M10 BOLT SECURING CHAIN TENSIONER.
  2. TENSION CHAIN BY ADJUSTING TENSIONER USING SPANNER IN DIRECTION OF ARROW "X" UNTIL SETTING OF 15-20 IS REACHED.
  3. RE-TIGHTEN M10 BOLT TO SECURE TENSIONER IN POSITION.



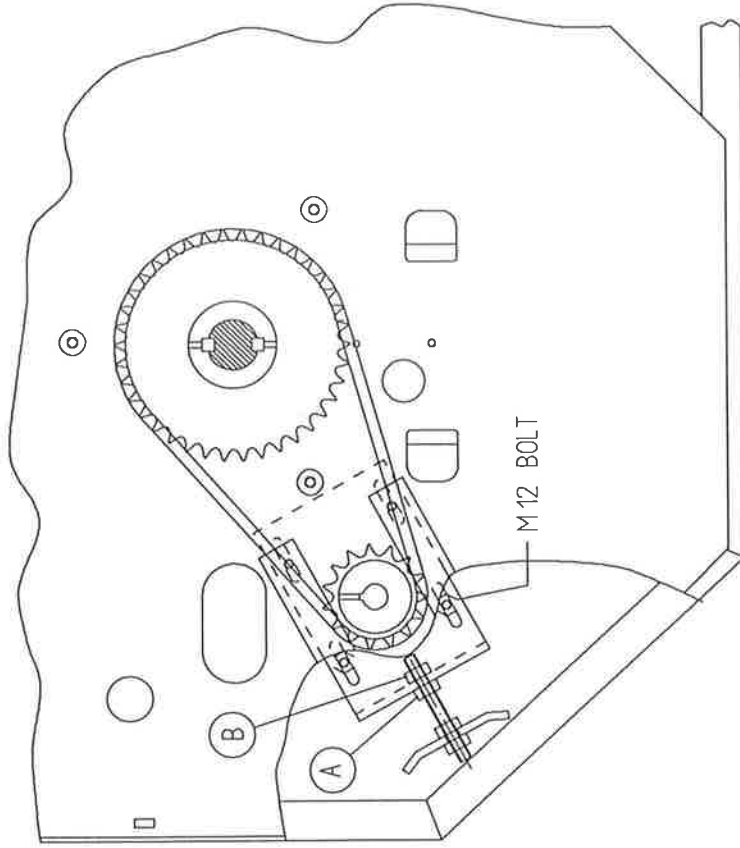
**ROLLER CHAIN DRIVE TENSIONING SYSTEM**



- CHAIN TENSIONING PROCEDURE
1. LOOSEN M14 BOLTS SECURING BEARING.
  2. TENSION CHAIN BY LOOSENING LOCKING NUT AND TURNING ADJUSTER BOLT CLOCKWISE TO TAKE UP SLACK IN CHAIN. SECURE IN POSITION WITH LOCKING NUT. ENSURE EQUAL ADJUSTMENTS ARE MADE ON BOTH SIDES.
  3. RE-TIGHTEN M14 BOLTS SECURING BEARINGS TO 170 Nm. (125 FT. lbs.).

**Fig. 3**

# TANCO AUTOWRAP TURNTABLE CHAIN DRIVE TENSIONING SYSTEM



## TENSIONING PROCEDURE

1. TIP UP MACHINE AND SUPPORT WITH A PROP.
2. REMOVE CHAIN GUARD.
3. SLACKEN M12 CLAMPING BOLTS SLIGHTLY.
4. SLACKEN LOCKNUT A.
5. ADJUST NUT B UNTIL THERE IS 8 mm - 10 mm DEFLECTION ON CHAIN.

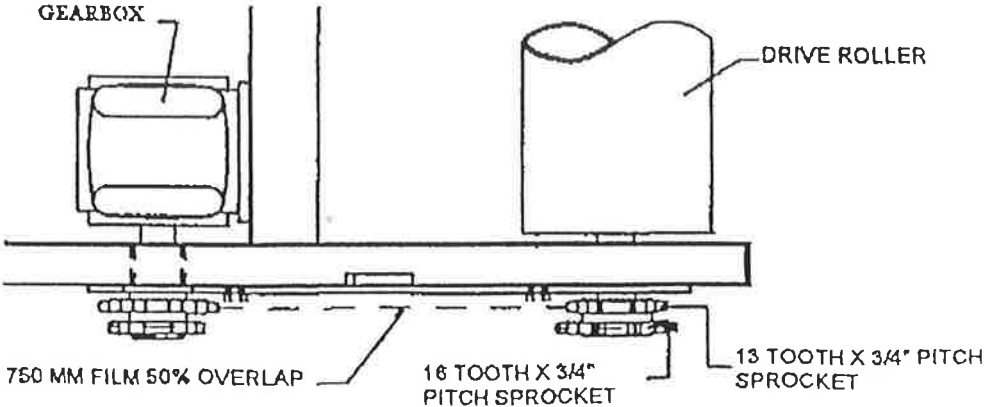
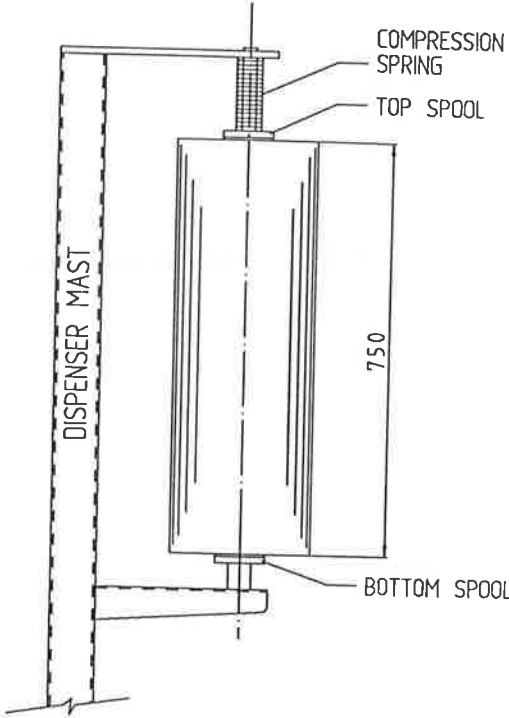
NOTE WARNING:  
DO NOT OVER TENSION CHAIN AS MOTOR WILL BE DAMAGED

6. TIGHTEN LOCKNUT A.
7. TIGHTEN M12 CLAMPING BOLTS.
8. REFIT CHAIN GUARD.

Fig. 8

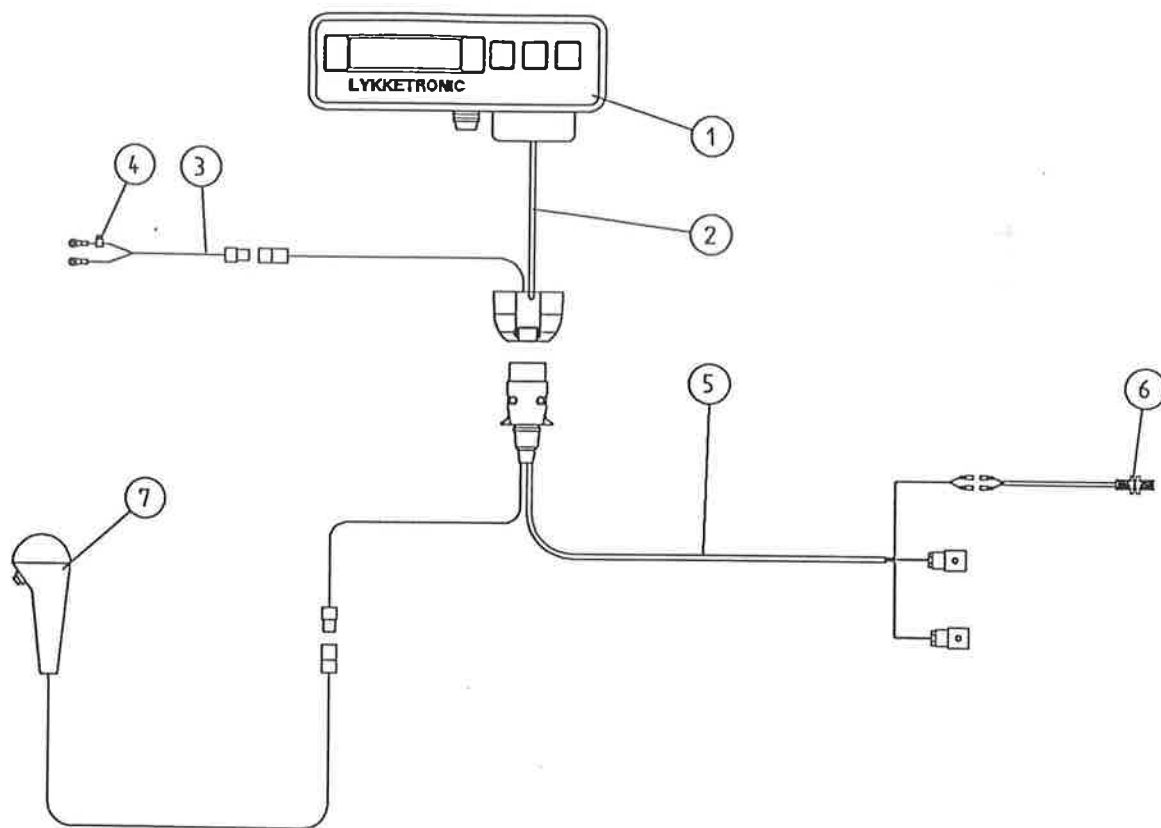
# DISPENSER MAST

All Autowrap models use 750mm wide film rolls as standard.  
See diagram for fitting roll of film.



TANCO AUTOWRAP 580S MODEL  
ELECTRIC COMPONENTS

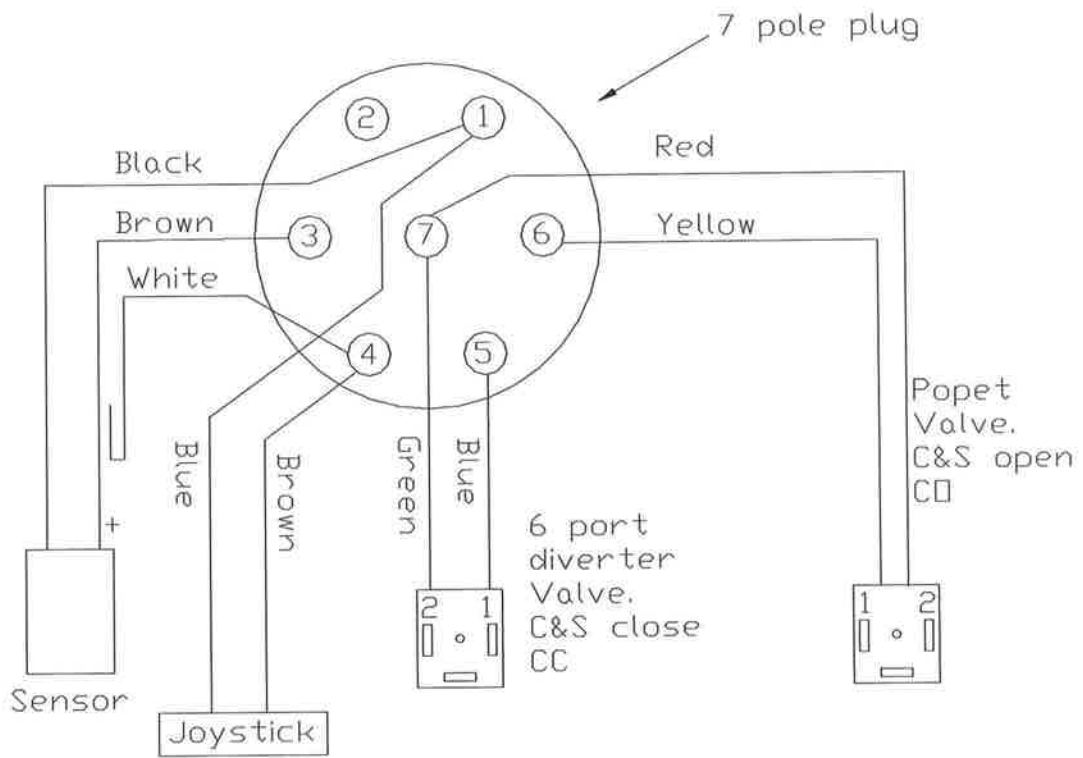
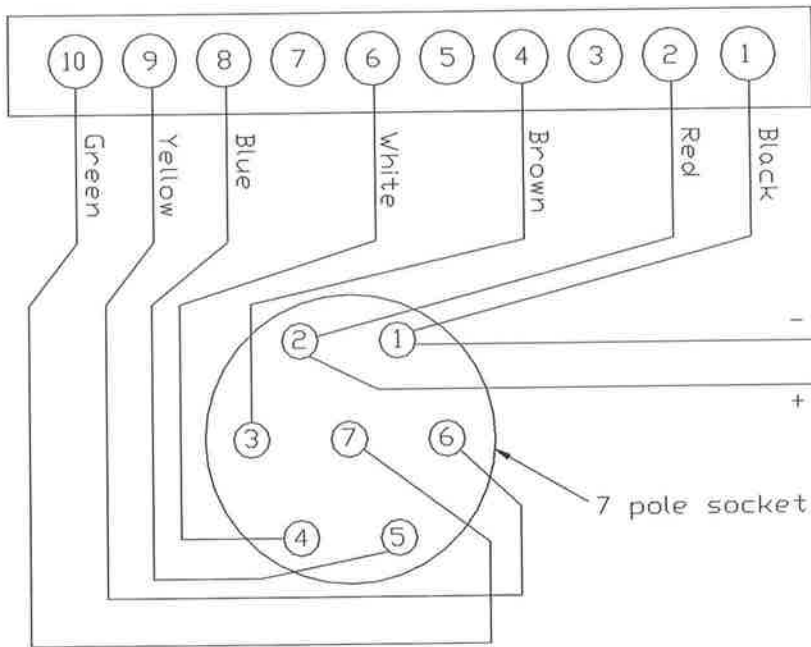
2003A



PARTS LIST

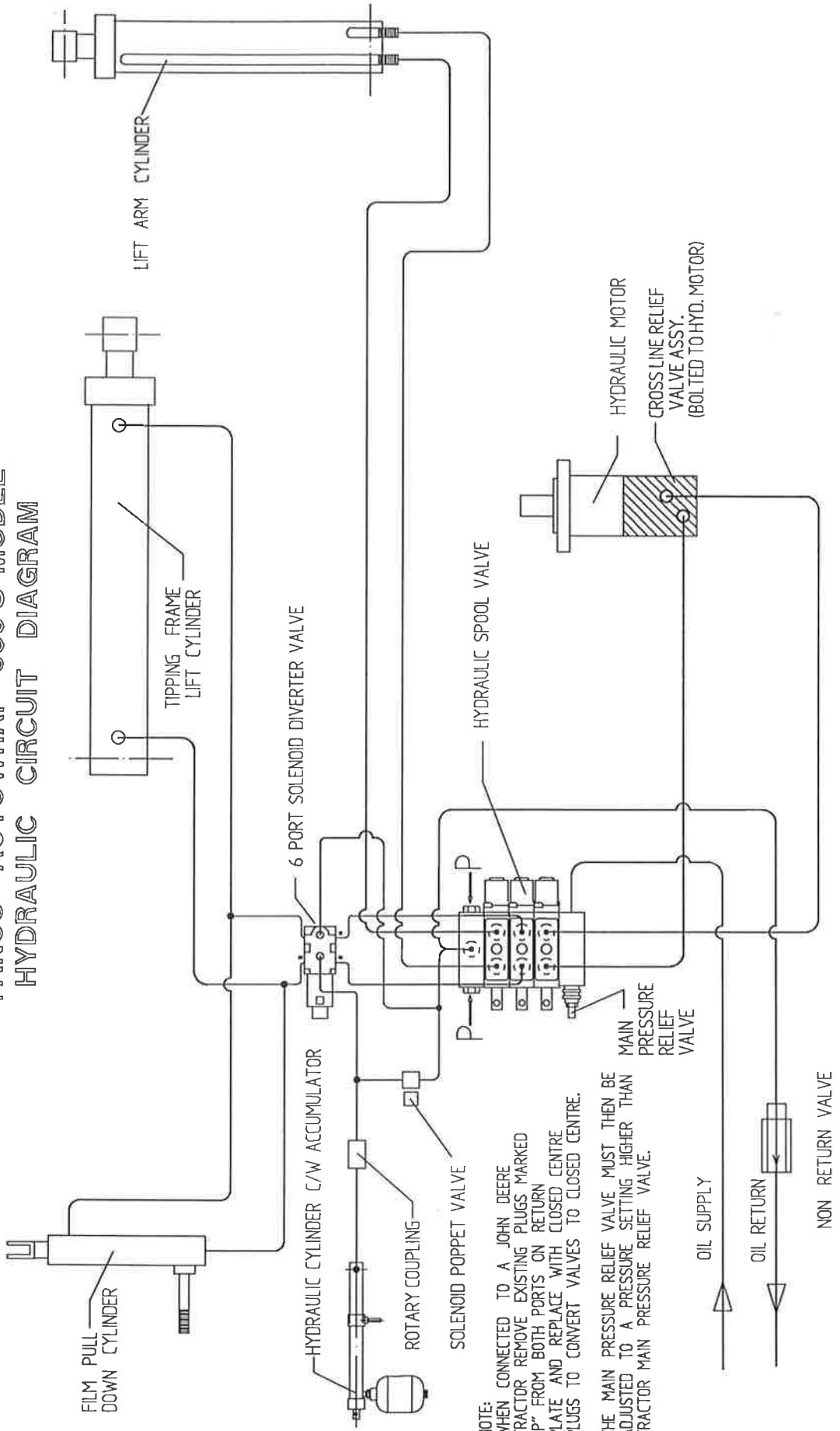
ITEM No.	DESCRIPTION	QTY.	PART No.
1	LYKKETRONIC PX MONITOR	1	D606C-S
2	7 PIN SOCKET CABLE 200mm LONG	1	ZLY-P08
3	MAIN BATTERY LEAD	1	ZLY-P12
4	7.5 AMP INLINE FUSE	1	ZD606-108
5	7 CORE CABLE C/W CONNECTORS	1	ZLY-P13
6	ROTATE SENSOR	1	ZLY-P14
7	JOYSTICK C/W MICROSWITCH	1	Z004-03-018

# Electrical circuit Diagram for Tanco 580S wrapper





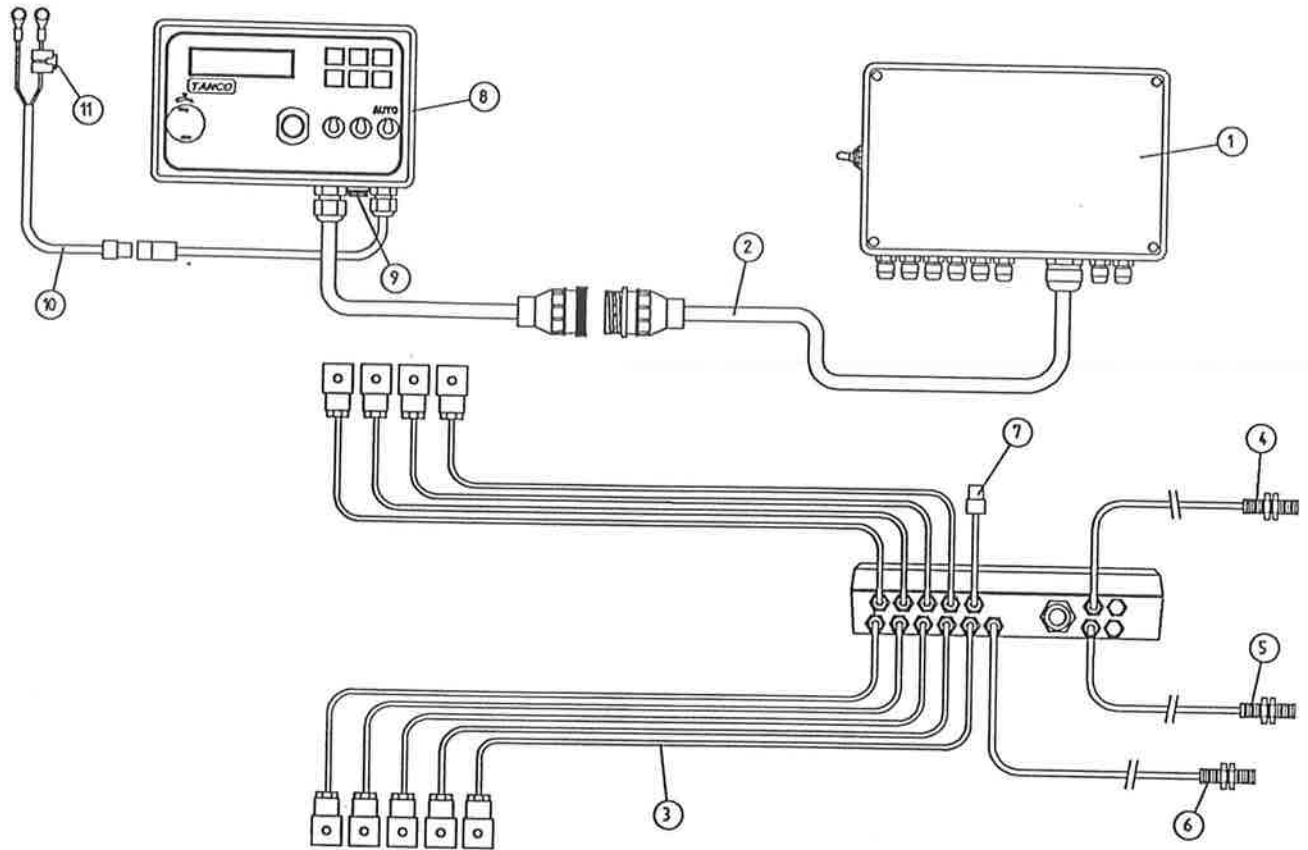
# TANCO AUTOWRAP 580 S MODEL HYDRAULIC CIRCUIT DIAGRAM



NOTE: WHEN CONNECTED TO A JOHN DEERE TRACTOR REMOVE EXISTING PLUGS MARKED "P" FROM BOTH PORTS ON RETURN PLATE AND REPLACE WITH CLOSED CENTRE PLUGS TO CONVERT VALVES TO CLOSED CENTRE.

THE MAIN PRESSURE RELIEF VALVE MUST THEN BE ADJUSTED TO A PRESSURE SETTING HIGHER THAN TRACTOR MAIN PRESSURE RELIEF VALVE.

# TANCO AUTOWRAP 580A MODEL ELECTRIC COMPONENTS



## PARTS LIST

ITEM No.	DESCRIPTION	QTY.	PART No.
1	JUNCTION BOX	1	ZLY-580A
2	24 CORE INTERCONNECTING LEAD C/W CONNECTORS	1	ZLY-P02
3	LOOM FOR VALVE C/W HERSCHMAN	9	ZLY-P03
4	LIFT ARM SENSOR	1	ZLY-P04
5	TIP SENSOR	1	ZLY-P05
6	ROTATE SENSOR	1	ZLY-P06
7	SYSTEM PRESSURE LEAD	1	ZLY-P07
8	CONTROL BOX (580A)	1	D606C-A
9	FUSE 16AMP	1	ZLY-P09
10	MAIN BATTERY LEAD	1	ZLY-P10
11	INLINE FUSE	1	ZLY-P11